

Live without limits.

Discount 6%



MEDm&bility
5711- Calgary Trail NW
Edmonton AB T6H 2K1
P:780-437-3300 • F:780-430-9381
AADL Vendor # 0000612578-001

ORDER FORM

Print pages 1-23 to exclude pictures.

Q700M with SEDEO® PRO™, SEDEO LITE™ and JAY Syncra Seating **AADL - W581 EIPW25**

March 2021

Customer	Ship To
Account #	Name
Date	Address
PO#	City
Buyer	Province
Mark For	Phone

MEDm&bility
5711- Calgary Trail NW
Edmonton AB T6H 2K1
P:780-437-3300 • F:780-430-9381
AADL Vendor # 0000612578-001

Client Measurements

a) Top of head to seat	in
b) Top of shoulder to seat	in
c) Underarm to seat	in
d) Elbow to seat	in
e) Top of leg to seat	in
f) Shoulder width	in
g) Chest width	in
i) Hip width	in
j) Actual sitting depth	in
m) Foot length	in
n) Knee to foot	in
o) Seat width	in

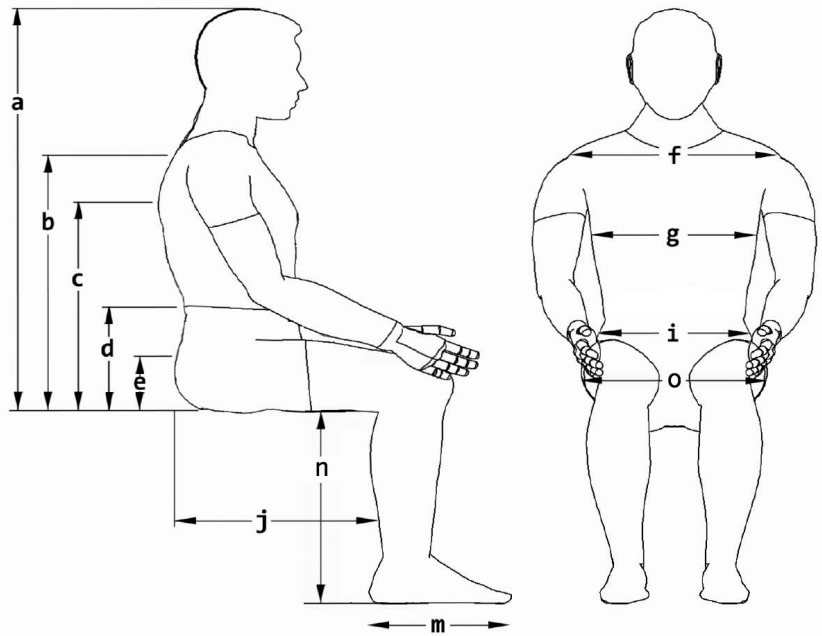

Notes

Chair Specifications

Weights Starting at: (with Batteries)	NPC: 294 lbs. SPC: 318 lbs.
Power Seating	50° of CG Tilt 12" seat elevator
Seat Type	SEDEO® PRO™ / SEDEO® LITE™ / JAY Syncra
Seat Size Range	Width 15" to 20" Depth 16" to 22"
Seat-to-Floor Height Range	16.5" to 19"

Mid-Wheel Drive Base Specifications

Drive Wheel Position	Mid-wheel drive
User Weight Capacity	250 lbs. / 300 lbs. / 350 lbs. HD / 450 lbs. HD
Base Size	Width 25", Length 36.5"
Minimum Turning Radius	19.8" (excludes footplates)
Drive Control	R-net PM 120A / R-net PM 90A
Driving Range	Up to 18 miles (w/ Group 24 Batteries)
Drive Motors	4-pole 6 mph, 5 mph HD, 8 mph
Drive Wheels	14" w/flat-free inserts (black) 14" w/pneumatic inserts (black)
Casters	6" front / 6" rear (black)
Charger	10A Dual Mode (Compact)
Battery Size	Group 24 / Group 34
Color	Matte Black with 6 color accents
Maximum Ground Clearance	3"

BASE			
OPTION		DESCRIPTION	RETAIL
Standard Duty Mid Wheel Drive Base <i>End Item Number EIPW25 (PRO™ Seat)</i>			\$
250PC197		Quickie Q700 M NPC No Power Option for SEDEO® PRO™ Seat Included in Base Pricing : Q700 M Base, R-net 90amp Electronics for No Power Seat Functions, SpiderTrac 2.0 Six-Wheel Independent Suspension, 14" Drive Wheels with Dual Density Inserts, 6" Flat Free Casters, ISO Occupied Tie-Down Brackets and 10amp Charger. Max Speed = 6mph, Weight Capacity = 300lbs., STFH = 16.5".	\$8,300.00
250PC198		Quickie Q700 M SPC Single Power Option for SEDEO® PRO™ Seat Included in Base Pricing : Q700 M Base, R-net 90amp Electronics for Single Power Seat Functions, SpiderTrac 2.0 Six-Wheel Independent Suspension, 14" Drive Wheels with Dual Density Inserts, 6" Flat Free Casters, ISO Occupied Tie-Down Brackets and 10amp Charger. Max Speed = 6mph, Weight Capacity = 300lbs., STFH = 16.5".	\$8,300.00
250PC198		Quickie Q700 M MPC Multi Power Option for SEDEO® PRO™ Seat Included in Base Pricing: Q700 M Base, R-net 90amp Electronics for Multiple Power Seat Functions, SpiderTrac 2.0 Six-Wheel Independent Suspension, 14" Drive Wheels with Dual Density Inserts, 6" Flat Free Casters, ISO Occupied Tie-Down Brackets and 10amp Charger. Max Speed = 6mph, Weight Capacity = 300lbs., STFH = 16.5".	\$8,300.00
Heavy Duty Mid Wheel Drive Base <i>End Item Number EIPW25 (PRO™ Seat)</i>			\$
250PC199		Quickie Q700 M NPC HD No Power Option for SEDEO® PRO™ Seat Included in Base Pricing : Q700 M Base, R-net 90amp Electronics for No Power Seat Functions, SpiderTrac 2.0 Six-Wheel Independent Suspension, 14" Drive Wheels with Dual Density Inserts, 6" Flat Free Casters, ISO Occupied Tie-Down Brackets and 10amp Charger. Max Speed = 5mph, Weight Capacity = 450lbs., STFH = 16.5".	\$9,200.00
250PC200		Quickie Q700 M SPC HD Single Power Option for SEDEO® PRO™ Seat Included in Base Pricing : Q700 M Base, R-net 90amp Electronics for Single Power Seat Functions, SpiderTrac 2.0 Six-Wheel Independent Suspension, 14" Drive Wheels with Dual Density Inserts, 6" Flat Free Casters, ISO Occupied Tie-Down Brackets and 10amp Charger. Max Speed = 5mph, Weight Capacity = 450lbs., STFH = 16.5".	\$9,200.00
250PC204		Quickie Q700 M MPC HD Multi Power Option for SEDEO® PRO™ Seat Included in Base Pricing : Q700 M Base, R-net 90amp Electronics for Multi Power Seat Functions, SpiderTrac 2.0 Six-Wheel Independent Suspension, 14" Drive Wheels with Dual Density Inserts, 6" Flat Free Casters, ISO Occupied Tie-Down Brackets and 10amp Charger. Max Speed = 5mph, Weight Capacity = 450lbs., STFH = 16.5".	\$9,200.00
High Performance 8mph Mid Wheel Drive Base <i>End Item Number EIPW25 (PRO™ Seat)</i>			\$
250PC201		Quickie Q700 M NPD HD No Power Option for SEDEO® PRO™ Seat Included in Base Pricing : Q700 M Base, R-net 120amp Electronics for No Power Seat Functions, SpiderTrac 2.0 Six-Wheel Independent Suspension, 14" Drive Wheels with Dual Density Inserts, 6" Flat Free Casters, ISO Occupied Tie-Down Brackets and 10amp Charger. Max Speed = 8mph, Weight Capacity = 300lbs., STFH = 16.5".	\$9,950.00
250PC202		Quickie Q700 M SPD HD Single Power Option for SEDEO® PRO™ Seat Included in Base Pricing : Q700 M Base, R-net 120amp Electronics for Single Power Seat Functions, SpiderTrac 2.0 Six-Wheel Independent Suspension, 14" Drive Wheels with Dual Density Inserts, 6" Flat Free Casters, ISO Occupied Tie-Down Brackets and 10amp Charger. Max Speed = 8mph, Weight Capacity = 300lbs., STFH = 16.5".	\$9,950.00
250PC203		Quickie Q700 M MPD HD Multi Power Option for SEDEO® PRO™ Seat Included in Base Pricing : Q700 M Base, R-net 120amp Electronics for Multi Power Seat Functions, SpiderTrac 2.0 Six-Wheel Independent Suspension, 14" Drive Wheels with Dual Density Inserts, 6" Flat Free Casters, ISO Occupied Tie-Down Brackets and 10amp Charger. Max Speed = 8mph, Weight Capacity = 300lbs., STFH = 16.5".	\$9,950.00

BASE			
OPTION		DESCRIPTION	RETAIL
Standard Duty Mid Wheel Drive Base <i>End Item Number EIPW25 (LITE™ Seat)</i>			\$
250PC267		Quickie Q700 M NPC No Power Option for SEDEO® LITE™ Seat Included in Base Pricing : Q700 M Base, R-net 90amp Electronics for No Power Seat Functions, SpiderTrac 2.0 Six-Wheel Independent Suspension, 14" Drive Wheels with Dual Density Inserts, 6" Flat Free Casters, ISO Occupied Tie-Down Brackets and 10amp Charger. Max Speed = 6mph, Weight Capacity = 300lbs., STFH = 16.5".	\$8,300.00
250PC268		Quickie Q700 M SPC Single Power Option for SEDEO® LITE™ Seat Included in Base Pricing : Q700 M Base, R-net 90amp Electronics for Single Power Seat Functions, SpiderTrac 2.0 Six-Wheel Independent Suspension, 14" Drive Wheels with Dual Density Inserts, 6" Flat Free Casters, ISO Occupied Tie-Down Brackets and 10amp Charger. Max Speed = 6mph, Weight Capacity = 300lbs., STFH = 16.5".	\$8,300.00
Heavy Duty Mid Wheel Drive Base <i>End Item Number EIPW25 (LITE™ Seat)</i>			\$
250PC269		Quickie Q700 M NPC HD No Power Option for SEDEO® LITE™ Seat Included in Base Pricing : Q700 M Base, R-net 90amp Electronics for No Power Seat Functions, SpiderTrac 2.0 Six-Wheel Independent Suspension, 14" Drive Wheels with Dual Density Inserts, 6" Flat Free Casters, ISO Occupied Tie-Down Brackets and 10amp Charger. Max Speed = 5mph, Weight Capacity = 350lbs., STFH = 16.5".	\$9,200.00
250PC270		Quickie Q700 M SPC HD Single Power Option for SEDEO® LITE™ Seat Included in Base Pricing : Q700 M Base, R-net 90amp Electronics for Single Power Seat Functions, SpiderTrac 2.0 Six-Wheel Independent Suspension, 14" Drive Wheels with Dual Density Inserts, 6" Flat Free Casters, ISO Occupied Tie-Down Brackets and 10amp Charger. Max Speed = 5mph, Weight Capacity = 350lbs., STFH = 16.5".	\$9,200.00
High Performance 8mph Mid Wheel Drive Base <i>End Item Number EIPW25 (LITE™ Seat)</i>			\$
250PC271		Quickie Q700 M NPD No Power Option for SEDEO® LITE™ Seat Included in Base Pricing : Q700 M Base, R-net 90amp Electronics for No Power Seat Functions, SpiderTrac 2.0 Six-Wheel Independent Suspension, 14" Drive Wheels with Dual Density Inserts, 6" Flat Free Casters, ISO Occupied Tie-Down Brackets and 10amp Charger. Max Speed = 8mph, Weight Capacity = 300lbs., STFH = 16.5".	\$9,950.00
250PC272		Quickie Q700 M SPD Single Power Option for SEDEO® LITE™ Seat Included in Base Pricing : Q700 M Base, R-net 90amp Electronics for Single Power Seat Functions, SpiderTrac 2.0 Six-Wheel Independent Suspension, 14" Drive Wheels with Dual Density Inserts, 6" Flat Free Casters, ISO Occupied Tie-Down Brackets and 10amp Charger. Max Speed = 8mph, Weight Capacity = 300lbs., STFH = 16.5".	\$9,950.00



BASE				
OPTION		DESCRIPTION	RETAIL	
User Weight			\$	
250WG22		Up to 250 lbs.	NC	
250WG03		251 to 300 lbs.	NC	
250WG15		301 to 350 lbs.	NC	
250WG25		351 to 450 lbs.	NC	
Motor Package			\$	
250PF98		4-pole 8 kph / 5 mph <i>(Standard for Group 3 HD)</i>	NC	
250PF99		4-pole 10 kph / 6 mph <i>(Standard for Group 3)</i>	NC	
250PF101		4-pole 12.5 kph / 8 mph <i>(Upgrade for Group 3)</i>	\$1,170.00	
Tracking			\$	
250MI01		SureTrac® Module & Motor Encoders <i>(Improves drive tracking)</i>	\$1,565.00	
Drive Wheels  P. 24			\$	
250DW58		Drive Wheel, 14", Dual Density, Knobby, Black	NC	
250DW68		Drive Wheel, 14", Pneumatic, V-type, Black	\$325.00	
Caster Wheels  P. 24			\$	
250CW55		Caster Wheels 6", Solid, Black	NC	
Wheel Locks			\$	
250WL42		Wheel Locks	\$105.00	
Shroud Color			\$	
		Color Accents		
250C119		Matte Black	Choose Color	NC
250C125		Pearl White	Black	NC
250C165		Candy Apple Red	Black	NC
250C166		Candy Blue	Black	NC
250C167		Candy Purple	Black	NC
250C176		Green Apple	Black	NC
250C178		Pearl Pink	Black	NC
250C182		Silver	Black	NC
250C170		American Flag	Black	\$150.00
Color Accents			\$	
250EZ20		Apple Green		NC
250EZ22		Black		NC
250EZ21		Blue		NC
250EZ23		Orange		NC
250EZ24		Red		NC
250EZ19		White		NC
250EZ25		Silver		NC

BASE			
OPTION		DESCRIPTION	RETAIL
ISO Transit Tie Downs			\$
250T050		ISO Transit Package	NC
LED Lights  P. 23			\$
250LI04		LED Lights and Indicators	\$1,131.00
250LI02		Omit LED Lights	NC

Seat Heights \$

Note: Available seat-to-floor heights are dependent on 2 options: **1- Battery Size** and **2- Powered Seating**. Use the matrix below to determine available ranges for your desired options. Measured from front of seat pan to floor with 0° frame angle.

	Seat Height	Power Seating	No Power Seating	
250HT103	16.5"	Group 34	Group 34	NC
250HT55	17"	Group 34	GP24 or GP34	NC
250HT104	17.5"	Group 34	GP24 or GP34	NC
250HT56	18"	GP24 or GP34	GP24 or GP34	NC
250HT105	18.5"	GP24 or GP34	GP24 or GP34	NC
250HT57	19"	GP24 or GP34	GP24 or GP34	NC

Batteries and Chargers  P. 24 \$

Group 24 Battery Options (Recommended for max daily range)

250AG25		GP24 Flat Top Pair w/Strap MK Gel	\$881.00
250AG26		GP24 Flat Top Pair w/Strap Brightway AGM	\$844.00

Group 34 Battery Options (Required for lower seat-to-floor heights)

250AG27		GP34 Flat Top Pair w/Straps MK Gel	\$881.00
250AG29		GP34 Flat Top Pair w/Straps Brightway AGM	\$796.00

Group 22 Battery

250AG31		GP22 Flat Top Pair w/ Straps (N/A with 10A Charger)	\$626.00
---------	--	---	----------

Omit Batteries

250AG24		Battery Harnesses Only (Omit Batteries)	NC
---------	--	---	----

Chargers

250BJ28		10A Dual Mode (Compact) Power First	NC
---------	--	-------------------------------------	----



POWERED SEATING			
OPTION		DESCRIPTION	RETAIL
Power Seating Options  P. 24			\$
Seat Elevator			
250PI07		Seat Elevator, Powered, 300 mm / 12" (Not available with HD)	\$3,209.00
250PI08		C-Me® Seat Elevator, Powered, 300 mm / 12" (Not available with HD model) For users less than 250 lbs. C-Me speed can reach 3 mph. For users 251 to 300 lbs. C-Me speed can reach 2.4 mph.	\$3,209.00
Seat Tilt			
250PA35		Posterior 50° Tilt	\$7,995.00
250PA36		Posterior 50° HD Tilt	\$8,235.00
Seat Recline			
250PA37		150° Powered Recline w/ 4" Shear Reduction	\$7,385.00
250PA38		130° Powered Semi-Recline	\$6,885.00
250PA39		150° HD Powered Recline w/ 4" Shear Reduction	\$8,235.00
Seat Tilt/Recline			
250PA41		Posterior 50° Tilt and 150° Recline Powered, w/ 4" Shear Reduction	\$12,252.00
250PA42		Posterior 50° Tilt and 130° Semi-Recline Powered	\$11,752.00
250PA43		Posterior 50° HD Tilt and 150° HD Recline Powered, w/ 4" Shear Reduction	\$13,282.00
Pre Set Seat Frame Angle (No Power Seating Options, Increases Seat to Floor Height)			\$
250FA10		0° (Adds 0" to STFH)	NC
250FA3		3° (Adds 1" to STFH)	NC
250FA4		6° (Adds 2" to STFH)	NC
250FA5		9° (Adds 3" to STFH)	NC
Backrest Frame Type			\$
250BF10		Tool Angle Adjustable Back, 90°-120°	NC
250BF11		User Adjustable Manual Semi-Recline Back, 90°-130°, Right (Adjustment Lever Mounted on Opposite Side of Joystick)	\$760.00
250BF12		User Adjustable Manual Semi-Recline Back, 90°-130°, Left (Adjustment Lever Mounted on Opposite Side of Joystick)	\$760.00
Backrest Frame Option			\$
250BF23		Flip Down, Quick Release	\$165.00
Back Cushion Type			\$
250BT134		SEDEO® Back Cushion (Choose Seating in Section B)	NC
250BT148		SEDEO® LITE™ Sling Back with Tension Adjustable Straps (Choose Seating in Section A)	NC
250BT134		JAY® Syncra™ (Choose Seating in Section C)	NC
250BT135		JAY® J3® (Choose Seating in Section D)	NC
250BT136		JAY® J3® Interface Only (Allows Personalized JAY Backs)	NC
250BT137		SEDEO® PRO™ Aftermarket Back Adapter (Height Adjustable Round Tubes for Traditional Mounting)	\$585.00
250BT133		OMIT (For personalized mounting. No headrest mount)	NC

POWERED SEATING					
OPTION		DESCRIPTION			RETAIL
A - SEDEO® LITE™ Backrest Frame (Angle Adjustable 86° - 106°)					\$
Back Frame Width					
250BF21		Width Adjustable, 385 - 485 mm / 15" - 19"			NC
250BF22		Width Adjustable, 460 - 510 mm / 18" - 20"			NC
Back Cane Height					
250B263		Standard, 18" - 20"			NC
250B264		Tall, 21" - 23"			NC
Backrest Frame Options					\$
250BF23		Flip Down, Quick Release			\$165.00
250BF24		Removeable			NC
A - SEDEO® LITE™ Sling Back Dimensions					
Installed Back Height - (From Pan to Top of Back)					
250JR71		18"			NC
250JR72		19"			NC
250JR73		20"			NC
250JR74		21"			NC
250JR75		22"			NC
250JR76		23"			NC
B - SEDEO® Backrest Dimensions					\$
Back Width					
250BN28		400mm / 16"			NC
250BN29		460mm / 18"			NC
250BN30		500mm / 20"			NC
250BN31		560mm / 22"			NC
Back Shell Height					
			Tool Angle Adj.	130° Recline	150° Recline
250B255		460mm / 18"	22" - 23"	22"-24"	23"-25"
250B256		560mm / 22"	24" - 27"	25" - 27"	26"-29"
250B257		660mm / 26"	28" - 30"	28" - 30"	30"
					Installed Back Height
Installed Back Height - (From Pan to Top of Back)					
250JR32		22"			NC
250JR33		23"			NC
250JR34		24"			NC
250JR35		25"			NC
250JR36		26"			NC
250JR37		27"			NC
250JR38		28"			NC
250JR39		29"			NC
250JR40		30"			NC

POWERED SEATING

OPTION	DESCRIPTION	RETAIL
--------	-------------	--------

Lateral Thoracic Support Pads

250KD31	Lateral, Swing-Away, Adjustable, Long Pad 150 x 130 mm / 6" x 5" , Right	\$67.00
250KD32	Lateral, Swing-Away, Adjustable, Long Pad 150 x 130 mm / 6" x 5" , Left	\$67.00
250KD33	Lateral, Swing-Away, Adjustable, Short Pad 90 x 120 mm / 3.5" x 4.5" , Right	\$67.00
250KD34	Lateral, Swing-Away, Adjustable, Short Pad 90 x 120 mm / 3.5" x 4.5" , Left	\$67.00

Lateral Thoracic Swing-Away Hardware

250KE45	Lateral Swing-Away Hardware, Right	\$300.00
250KE46	Lateral Swing-Away Hardware, Left	\$300.00

C- JAY® Syncra™ Back NEW \$

250JP14	JAY® Syncra™ Back 16-20" Wide with 3" Contour Depth	\$1,250.00
250JP15	JAY® Syncra™ Back 22" Wide with 3" Contour Depth	\$1,250.00

C - JAY® Syncra™ Back Width NEW \$

Back can be ordered a different width than seat pan. Armrest will be adjusted to back width ordered.

250JQ07	16" Wide (Adjustment range 16 to 17" Wide)*	NC
250JQ08	18" Wide (Adjustment range 18 to 19" Wide)*	NC
250JQ09	20" Wide (Adjustment range 20 to 21" Wide)*	NC
250JQ10	22" Wide (Adjustment range 22 to 23" Wide)*	NC

**Additional +1" of shell width adjustment is achievable. Requires purchase of 1" larger foam and upholstery separately.*

C - JAY® Syncra™ Back Shell Options and Height Ranges NEW \$

JAY® Syncra™ Back shells are mounted with a minimim 5.5" gap between the bottom of the shell to the seat pan to accommodate the mechanical shear. Back height can be adjusted in the field with-in the ranges shown based on the back frame type.

JAY® Syncra™ Shell Height

250JR42	16" Tall Shell (22" to 24" Back Height)	NC
250JR43	18" Tall Shell (24" to 26" Back Height)	NC
250JR44	20" Tall Shell (26" to 28" Back Height)	NC
250JR45	22" Tall Shell (28" to 30" Back Height)	NC

JAY® Syncra™ Back Installed Back Height (From Pan to Top of Back)

250JR50	22" (16" Shell Height)	NC
250JR51	23" (16" Shell Height)	NC
250JR52	24" (16" Shell Height)	NC
250JR53	24" (18" Shell Height)	NC
250JR54	25" (18" Shell Height)	NC
250JR55	26" (18" Shell Height)	NC
250JR56	26" (20" Shell Height)	NC
250JR57	27" (20" Shell Height)	NC
250JR58	28" (20" Shell Height)	NC
250JR67	28" (22" Shell Height)	NC
250JR68	29" (22" Shell Height)	NC
250JR69	30" (22" Shell Height)	NC

C - JAY® Syncra™ Back Upholstery

250BU96	Syncra™ Premium Leatherette	NC
250BU97	Syncra™ Stretch	NC
250BU98	Syncra™ 3DX Microclimatic	NC

POWERED SEATING

OPTION	DESCRIPTION	RETAIL
D - JAY® J3® Back - Contour  P. 24 \$		
250JP01	J3® PA Back for 16"-20" Wide	\$852.00
250JP02	J3® PA Back for 22" Wide	\$1,812.00
250JP11	J3® PL Back for 16"-20" Wide	\$920.00
250JP13	J3® PD Back for 16"-20" Wide <i>(18" and 21" shell height only)</i>	\$997.00

D - JAY® J3® Back Width \$

Back can be ordered a different width than seat pan. Armrest will be adjusted to back width ordered.

250JQ02	16"	NC
250JQ03	18"	NC
250JQ04	20"	NC
250JQ05	22"	NC

D - JAY® J3® Back Shell Options and Height Ranges \$

JAY® J3® shells are mounted with a minimim 4" gap between the bottom of the shell to the seat pan to accommodate the mechanical shear. Back height can be adjusted in the field within the ranges shown, based on the back frame type and the amount of usable hardware adjustability.

JAY® J3® Shell Height

		Tool Angle Adj.	130° Recline	150° Recline		
250JR41	15" tall shell <i>(Upper Thoracic Med) for 22" Wide</i>	22" - 23"	21" - 22"	22" - 23"	Installed Back Height	NC
250JR14	16.5" tall shell <i>(Upper Thoracic Short)</i>	21" - 23"	21" - 22"	21" - 23"		NC
250JR15	18" tall shell <i>(Upper Thoracic Med)</i>	22" - 24"	22" - 24"	23" - 25"		NC
250JR16	19.5" tall shell <i>(Upper Thoracic Tall)</i>	24" - 26"	24" - 26"	24" - 26"		NC
250JR18	18" tall shell <i>(Shoulder Height) for 22" Wide</i>	25" - 26"	24" - 25"	25" - 26"		NC
250JR17	21" tall shell <i>(Shoulder Height)</i>	24" - 26"	25" - 27"	26" - 28"		NC
250JR27	22.5" tall shell <i>(Shoulder Height)</i>	26" - 28"	27" - 29"	27" - 29"		NC
250JR28	24" tall shell <i>(Shoulder Height)</i>	27" - 29"	28" - 30"	29" - 30"		NC

JAY® J3® Installed Back Height (From Pan to Top of Back)

250JR29	21"	NC
250JR19	22"	NC
250JR20	23"	NC
250JR21	24"	NC
250JR22	25"	NC
250JR23	26"	NC
250JR24	27"	NC
250JR25	28"	NC
250JR30	29"	NC
250JR31	30"	NC

D - JAY® J3® Back Spine-Align Fit Kit 2  P. 24 \$

250JS02	410 mm / 16"	\$202.00
250JS03	460 mm / 18"	\$202.00
250JS04	510 mm / 20"	\$202.00

POWERED SEATING

OPTION	DESCRIPTION	RETAIL
--------	-------------	--------

D - JAY® Anterior Thoracic Support  P. 25 \$

Classic-Structure Pull Down Harness (4 point strap, only available with JAY® backrest)

250K10	Medium (ATS8302)	\$300.00
250K11	Large (ATS8303)	\$300.00
250K12	Extra Large (ATS8304)	\$300.00

D - JAY® J3® Lateral Thoracic Swing-Away Supports \$

Lateral Thoracic Support Pads

250JW19	Lateral Thoracic (LxH) 100 mm x 100 mm / 4" x 4" Pad - Right	\$67.00
250JW25	Lateral Thoracic (LxH) 100 mm x 100 mm / 4" x 4" Pad - Left	\$67.00
250JW20	Lateral Thoracic (LxH) 100 mm x 127 mm / 4" x 5" Pad - Right	\$67.00
250JW26	Lateral Thoracic (LxH) 100 mm x 127 mm / 4" x 5" Pad - Left	\$67.00
250JW21	Lateral Thoracic (LxH) 100 mm x 152 mm / 4" x 6" Pad - Right	\$67.00
250JW27	Lateral Thoracic (LxH) 100 mm x 152 mm / 4" x 6" Pad - Left	\$67.00
250JW22	Lateral Thoracic (LxH) 152 mm x 100 mm / 6" x 4" Pad - Right	\$67.00
250JW28	Lateral Thoracic (LxH) 152 mm x 100 mm / 6" x 4" Pad - Left	\$67.00
250JW23	Lateral Thoracic (LxH) 152 mm x 127 mm / 6" x 5" Pad - Right	\$67.00
250JW29	Lateral Thoracic (LxH) 152 mm x 127 mm / 6" x 5" Pad - Left	\$67.00
250JW24	Lateral Thoracic (LxH) 152 mm x 152 mm / 6" x 6" Pad - Right	\$67.00
250JW30	Lateral Thoracic (LxH) 152 mm x 152 mm / 6" x 6" Pad - Left	\$67.00

Lateral Thoracic Swing-Away Fabric

250NU01	Syncra™ Premium Leatherette	\$67.00
250NU02	Syncra™ Stretch	\$67.00
250NU03	Syncra™ 3DX Microclimatic	\$67.00

Lateral Thoracic Swing-Away Hardware

250JW31	Lateral Thoracic Swing-Away Bracket - Right	\$300.00
250JW32	Lateral Thoracic Swing-Away Bracket - Left	\$300.00

Headrests (Requires Pad, Upholstery, & Mount)  P. 25 \$

Headrest Pad

250HE36	SEDEO® Pad Small With Cover (LxH) 240 x 150 mm / 10" x 6" <i>Can only be used with Multi Position Headrest Mount with Quick Release and SEDEO® Upholstery</i>	\$210.00
250HE37	SEDEO® Pad Flexible, (LxH) 400 x 110 mm / 16" x 4.5" <i>Can only be used with Multi Position Headrest Mount with Quick Release and SEDEO® Upholstery</i>	\$340.00
250HE38	Whitmyer® Plush Headrest Pad 203 mm / 8"	\$328.00
250HE39	Whitmyer® Plush Headrest Pad 254 mm / 10"	\$328.00
250HE44	Whitmyer® Plush Headrest Pad 356 mm / 14"	\$328.00
250HE45	Whitmyer® Adjust-A-Plush Headrest Pad Small (Narrow) (Adjustable from 6 to 14" Wide x 3" Tall)	\$387.00
250HE46	Whitmyer® Adjust-A-Plush Headrest Pad Medium (Adjustable from 7 to 16" Wide x 4" Tall)	\$387.00
250HE47	Whitmyer® Adjust-A-Plush Headrest Pad Large (Standard) (Adjustable from 8 to 18" Wide x 5" Tall)	\$387.00
250HE48	OMIT Headrest Pad	NC

POWERED SEATING

OPTION	DESCRIPTION	RETAIL
Headrest Pad Upholstery		
250NU10	SEDEO® Upholstery	NC
250NU04	Syncra™ Premium Leatherette	NC
250NU05	Syncra™ Premium Leatherette	NC
250NU06	Syncra™ Premium Leatherette	NC
250NU11	Whitmyer® Lycra	NC
Headrest Mount		
250MH32	SEDEO® Multi-Position Headrest Mount with Quick Release <i>(Only available with SEDEO® Pad)</i>	\$515.00
250MH33	Whitmyer® Linx Headrest Mount with Quick Release	\$215.00
250MH34	Whitmyer® Linx-2 Headrest Mount with Quick Release	\$260.00
250MH35	Whitmyer® AXYS Headrest Mount with Quick Release	\$215.00
250MH36	Whitmyer® AXYS Offset Headrest Mount with Quick Release	\$215.00
250MH37	Whitmyer® Cobra FB Headrest Mount with Quick Release	\$515.00
250MH17	OMIT Headrest Mount	NC
Push Handles		
250PH27	Height Adjustable Push Handles	\$57.00
Seat Frame Rails		
250SN14	Seat Rail Short, For Seat Depth 16" - 20" <i>(Effective depth 14" to 18")</i>	NC
250SN15	Seat Rail Long, For Seat Depth 19" - 22" <i>(Effective depth 17" to 20") (Not available with 16" seat width)</i>	NC
Seat Cushion Type		
250ST78	SEDEO® (See Section D)	NC
250ST79	JAY Syncra™ (See Section F)	NC
250ST80	JAY® (See Section E)	NC
250ST75	Omit	NC
Seat Size		
Seat Pan Width		
250R78	15" <i>(Not Available with Sedeo PRO)</i>	NC
250R53	16"	NC
250R54	17"	NC
250R55	18"	NC
250R56	19"	NC
250R57	20"	NC
250R58	21" <i>(Not Available with JAY® Syncra Cushions or Sedeo Lite)</i>	NC
250R59	22" <i>(Not Available with Sedeo Lite)</i>	NC
Seat Pan Depth (Front of Seat Pan to Back Structure. Back Cushions Can Cause 2" Loss of Effective Depth)		
250RF51	16"	NC
250RF45	17"	NC
250RF46	18"	NC
250RF47	19"	NC
250RF48	20"	NC
250RF49	21"	NC
250RF50	22"	NC
SEDEO® Cushions		
250CU82	SEDEO® Cushion <i>(Sizes 16", 18", & 20" Wide) (Not Available with 14" Depth)</i>	\$295.00
250CU83	SEDEO® Cushion <i>(Sizes 22" Wide)</i>	\$295.00

POWERED SEATING			
OPTION		DESCRIPTION	RETAIL
E - JAY® Seat Cushions			\$
250CU55		JAY® X2® Cushion (Sizes 16" - 20" Wide)	\$881.00
250CU56		JAY® J2® Cushion (Sizes 16" - 20" Wide)	\$777.00
250CU57		JAY® J2® Deep Contour Cushion (Sizes 16" - 20" Wide)	\$812.00
250CU58		JAY® J2® Deep Contour Cushion (Size 22" Wide)	\$1,021.00
250CU59		JAY® Ion® (Sizes 16" - 21" Wide)	\$613.00
250CU60		JAY® Ion® (Size 22" Wide)	\$652.00
250CU61		JAY® Union® (Sizes 16" - 21" Wide)	\$714.00
250CU62		JAY® Union® (Size 22" Wide)	\$753.00
250CU63		JAY® Union® Reduced Profile (Sizes 16" - 20" Wide)	\$714.00
250CU64		JAY® Fusion® with Cryo® Technology (Sizes 16" - 21" Wide)	\$976.00
250CU65		JAY® Fusion® with Cryo® Technology (Size 22" Wide)	\$1,095.00
250CU66		JAY® Fusion® Air Insert Single Valve (Sizes 16" - 21" Wide)	\$992.00
250CU67		JAY® Fusion® Air Insert Single Valve (Size 22" Wide)	\$1,111.00
250CU68		JAY® Fusion® Air Insert Dual Valve (Sizes 16" - 21" Wide)	\$976.00
250CU69		JAY® Fusion® Air Insert Dual Valve (Size 22" Wide)	\$1,095.00
250CU70		JAY® Fusion® Reduced Profile (Sizes 16" - 21" Wide)	\$976.00
250CU71		JAY® Fusion® Reduced Profile with Cryo® Technology (Sizes 16" - 21" Wide)	\$1,095.00
250CU72		JAY® Fusion® Reduced Profile Air Insert Single Valve (Sizes 16" - 21" Wide)	\$976.00
250CU73		JAY® Fusion® Reduced Profile Air Insert Dual Valve (Sizes 16" - 21" Wide)	\$1,095.00
250CU74		JAY® Fusion® Reduced Profile Air Insert Dual Valve (Sizes 16" - 21" Wide)	\$992.00
250CU75		JAY® Fusion® Reduced Profile Air Insert Dual Valve (Size 22" Wide)	\$1,111.00
250CU76		JAY® Fusion® Positioning (Sizes 16" - 21" Wide)	\$997.00
250CU77		JAY® Fusion® Positioning (Size 22" Wide)	\$1,108.00
250CU78		JAY® Fusion® Positioning Air Insert Single Valve (Sizes 16" - 21" Wide)	\$1,019.00
250CU79		JAY® Fusion® Positioning Air Insert Dual Valve (Sizes 16" - 21" Wide)	\$1,120.00
250CU80		JAY® Fusion® Positioning Air Insert Dual Valve (Sizes 16" - 21" Wide)	\$1,019.00
250CU81		JAY® Fusion® Positioning Air Insert Dual Valve (Size 22" Wide)	\$1,120.00
E - JAY® Solid Seat			\$
250CU84		JAY® Solid Seat	\$325.00
E- JAY® Bundling			\$
<i>Note: To order any JAY® cushion not listed above please see the JAY® price list.</i>			
250JC20	JAY® Bundled Cushion		See Price List
	Cushion name or part number	Width	Depth
F - JAY® Syncra Cushions			\$
250CU87		JAY® Syncra™ Cushion with Visco Foam (16" to 20" wide)	\$950.00
250CU88		JAY® Syncra™ Cushion with Visco Foam (22" wide)	\$950.00
250CU89		JAY® Syncra™ Cushion featuring JAY Flow® Fluid with Cryo™ Technology (16" to 20" wide)	\$950.00
250CU90		JAY® Syncra™ Cushion featuring JAY Flow® Fluid with Cryo™ Technology (22" wide)	\$1,050.00
250CU91		JAY® Syncra™ Cushion with Air Insert - Single Valve (16" to 20" wide)	\$1,050.00
250CU92		JAY® Syncra™ Cushion with Air Insert - Single Valve (22" wide)	\$1,050.00
250CU93		JAY® Syncra™ Cushion with Air Insert - Dual Valve (16" to 20" wide)	\$1,050.00
250CU94		JAY® Syncra™ Cushion with Air Insert - Dual Valve (22" wide)	\$1,050.00
JAY® Syncra™ Cushion Cover Upholstery			
250YR73		Syncra™ Premium Leatherette	NC
250YR74		Syncra™ Stretch	NC
250YR75		Syncra™ 3DX Microclimatic	NC

POSITIONING SUPPORTS & ACCESSORIES

OPTION	DESCRIPTION	RETAIL
--------	-------------	--------

Knee and Thigh Swing-Away Support Pads

\$

Lateral Knee Support Pads and Hardware (must pick pad and mount)

250XY05	Lateral Knee Support Pad, Right (4" round)	\$228.00
250XY06	Lateral Knee Support Pad, Left (4" round)	\$228.00
250XX08	Lateral Swing-Away Bracket Knee - Right	\$300.00
250XX09	Lateral Swing-Away Bracket Knee - Left	\$300.00

Lateral Thigh Support Pads and Hardware (must pick pad and mount)

250KF08	Lateral Thigh Support Pad, Right (5"x10")	\$134.00
250KF09	Lateral Thigh Support Pad, Left (5"x10")	\$134.00
250KF10	Lateral Removable Bracket Thigh - Right	\$300.00
250KF11	Lateral Removable Bracket Thigh - Left	\$300.00

JAY® Lateral Thigh Supports (Must pick pad, upholstery, and mount)

\$

JAY® Lateral Thigh Support Pads

250KF16	Lateral Thigh Support Standard, Right (8.25" x 3.25")	\$134.00
250KF17	Lateral Thigh Support Standard, Left (8.25" x 3.25")	\$134.00
250KF18	Lateral Thigh Support Large, Right (12" x 3.25")	\$134.00
250KF19	Lateral Thigh Support Large, Left (12" x 3.25")	\$134.00

JAY® Lateral Thigh Support Pad Upholstery

250NU07	Syncra™ Premium Leatherette	NC
250NU08	Syncra™ Stretch	NC
250NU09	Syncra™ 3DX Microclimatic	NC

JAY® Lateral Thigh Removable Mount

250KF20	Lateral Thigh Removable Mount - Right	\$300.00
250KF21	Lateral Thigh Removable Mount - Left	\$300.00

Armrest Structure  P. 26

\$

250EG35	Reclining, Flip Back (Height Adjustable 8" to 13")	NC
250EG36	Reclining, Flip Back with 2-point post locking arm (Height Adjustable 11" to 13" x .625")	\$325.00
250EG32	Single Post, Flip Back (N/A with thigh support) (Height Adjustable 10" to 15")	NC
250EG33	Single Post, Removable (N/A with thigh support) (Height Adjustable 10" to 15")	NC
250EG34	Single Post, SEDEO LITE, Removable (N/A with thigh support), (Height Adjustable 10" to 15")	NC

Arm Pads  P. 26

\$

SEDEO® Armrest Pad

250AB62	300 mm / 12", Integral Foam, Right	NC
250AE62	300 mm / 12", Integral Foam, Left	NC
250AB63	400 mm / 16", Integral Foam, Right	NC
250AE63	400 mm / 16", Integral Foam, Left	NC
250AB45	Wide, 450 mm, Integral Foam, Right (Increases armpad width by 1.5". May prevent flip-back.)	NC
250AE45	Wide, 450 mm, Integral Foam, Left (Increases armpad width by 1.5". May prevent flip-back.)	NC
250AB61	SEDEO LITE Pad, Right	NC
250AE61	SEDEO LITE Pad, Left	NC

POSITIONING SUPPORTS & ACCESSORIES

OPTION	DESCRIPTION	RETAIL
Comfort Arm Pad (Foam)		
250AB46	2" Wide Right	\$104.00
250AE46	2" Wide Left	\$104.00
250AB47	4" Wide Right	\$104.00
250AE47	4" Wide Left	\$104.00
Comfort Arm Pad (Gel)		
250AB48	2" Wide Right	\$197.00
250AE48	2" Wide Left	\$197.00
250AB49	4" Wide Right	\$197.00
250AE49	4" Wide Left	\$197.00
AES Trough/Elbow Block Arm Pads (Gel)		
250AB50	3.5" x 13" Right	\$274.00
250AE50	3.5" x 13" Left	\$274.00
250AB51	4" x 14.5" Right	\$274.00
250AE51	4" x 14.5" Left	\$274.00
Side Guards (Pair) \$		
250SG43	Side Guards (9"L x 5.5"H) (N/A with Reclining Armrests)	\$228.00
250SG44	Side Guards Integral Foam (11"L x 5.5"H) (N/A with Reclining Armrests)	\$328.00
250SG45	Side Guards Wedge Shaped, Padded ((18"L x 5"H, 3" thick in front, 1.5" thick in rear) (Only with Single Post Removable Armrests)	\$328.00
250SG46	Side Guards Mounted On Seat Rail Bracket (Only with Reclining Armrests) (N/A with Thigh Supports)	\$328.00
Fixed Centermount Legrest \$		
250H183	SEDEO® Fixed Centermount Legrest (3" to 17.5" Leg Length)	\$316.00
250H184	Fixed Centermount Legrest, Short (Includes Calf Pads & Single Footplate) (11.5" to 14.5" Leg Length)	NC
250H185	Fixed Centermount Legrest, Long (Includes Calf Pads & Single Footplate) (13.5" to 18.5" Leg Length)	NC
250H186	Angle Adjustable Centermount Legrest, Long (Only Available with Sedeo Lite) (11.5" to 18.5" Leg Length)	\$558.00
Power Centermount Legrest  P. 26 \$		
250H175	Power Centermount Legrest, 90° - 0° Angle, 7.5" Extension (Mechanical Articulation) (5" to 17.5" Leg Length)	\$2,295.00
250H109	Power Centermount Legrest, 90° - 0° Angle, 7.5" Extension (Powered Articulation) (3" to 17.5" Leg Length)	\$3,169.00
Power Centermount Legrest Accessories \$		
Footplates		
250F127	Dual, Height, Width and Angle Adjustable, Standard (14"W x 10"D)	\$262.00
250F128	Dual, Height, Width and Angle Adjustable, Large (16"W x 12"D)	\$262.00
Calf Pad Options		
250DI34	Calf Pads, Pair, Standard	NC
250DI35	Extra Large Pair Calf Pads for Centermount Legrests, Fully adjustable (N/A w/ Std footplates)	\$328.00

POSITIONING SUPPORTS & ACCESSORIES			
OPTION		DESCRIPTION	RETAIL
SEDEO® PRO™ Swing-Away Legrest (Pair)			\$
250H177		Legrests, Swing-Away, 70°, SEDEO® PRO™ (14" to 21" Leg Length)	NC
250H178		Legrests, Manual Elevating, Swing-Away, SEDEO® PRO™ (Includes Padded Calf Pads) (14".5 to 21.5" Leg Length)	\$558.00
250H179		Legrests, Power Elevating, Swing-Away, SEDEO® PRO™ (Includes Padded Calf Pads) (15.5" to 22.5" Leg Length)	\$3,169.00
250H180		Hanger Receivers Only, SEDEO® PRO™	NC
250DI76		Omit Legrests	NC
Swing-Away Legrest Footplates			
250F360		Footplate, For Seat Width 15" - 16"	\$262.00
250F361		Footplate, For Seat Width 17" - 18"	\$262.00
250F362		Footplate, For Seat Width 19" - 20"	\$262.00
250F363		Footplate, For Seat Width 21" - 22"	\$262.00
Swing-Away Legrest Calf Supports			
250DI41		Calf Support, Depth Adjustable, Integral Foam (7" Wide x 10" Tall, NA 16-17" W)	\$384.00
250DI42		Calf Support, Depth Adjustable, Padded (6.5" to 8" Wide, Depending On Chair Width, x 9.5" Tall)	\$472.00
Swing-Away Legrest Options			
250F364		Footplates, Coupled	\$262.00
250DI44		Heel Loops	NC
250DI40		Calf Strap (Only For 70° Swing-Away Legrests)	\$130.00
250KG4		Knee Pads, Integral Foam (2.5" Wide x 4.5" Tall)	\$260.00
SEDEO® Lower Extremity Swing-Away Support			
250VD01		Lower Extremity Support, Padded, Swing-Away, SEDEO®, Right	\$472.00
250VD02		Lower Extremity Support, Padded, Swing-Away, SEDEO®, Left	\$472.00
Pelvic Positioning Belts  P. 26			\$
250A837		Positioning Belt, Auto Style Buckle, 50 mm 1600 mm / 2"	NC
250A839		Positioning Belt, Aircraft Buckle, 50 mm x 1300 mm / 2"	NC
250A840		Positioning Belt, Aircraft Buckle, Padded 50 mm x 1300 mm / 2"	\$95.00
Accessories			\$
Ventilator Option			
250VT12		Vent Tray Fixed (Pulmonetic LTV Models)	\$562.00
O2 Tank Option			
250A718		O2 Tank Holder Mounted to Backrest (D and E Styles)	\$361.00
Wheelchair Tray Table			
2507A09		Tray, Swing-Away	\$351.00
Backpack			
250A1		Black Utility	\$103.00
Misc. Accessories			
2508A59		Transfer Bar (Pair)	\$455.00
2508A52		Ram Mount Phone	\$71.00
2508A53		Ram Mount Tablet	\$284.00
2508A54		Ram Mount Cup Holder	\$71.00
2508A58		Rear View Mirror	\$71.00

JOYSTICK / ELECTRONICS			
OPTION		DESCRIPTION	RETAIL
Seating Control <i>(Button Switches will not be mounted)</i>			\$
Switch Controls Only			
250E033		Dual Toggle for one Actuator	NC
250E034		Buddy Button for 1 actuator	NC
250E035		Switch-It Mini 1 button for 1 Actuator	NC
250E036		Switch-It Mini 2 button for 1 Actuator	NC
Toggle Mount			
250TN1		Toggle Mount, Right	NC
250TN2		Toggle Mount, Left	NC
Thru-Drive Control			
250E037		Thru-drive Control for 1 Actuator	\$1,332.00
250E038		Thru-drive Control for 2+ Actuators	\$2,679.00
Attendant Controls  P. 27			\$
2500A05		Dual Control Module for Attendant	\$1,131.00
2500A06		R-net Color LCD (CJSM1) Control Attendant Only	\$1,131.00
Attendant Mounting Location  P. 27			\$
250DN5		Right Back Cane	NC
2500DN6		Left Back Cane	NC
R-net Joystick <i>(Remote)</i>  P. 27			\$
250J121		Standard LED Joystick <i>(w/o Screen Display)</i>	NC
250J116		Color Joystick <i>(2.3" Color LCD Screen Display, CJSM1)</i>	NC
250J117		Heavy Duty Color Joystick <i>(2.3" Color LCD Screen Display, Fixed Joystick Mount Only)</i>	\$1,495.00
250J118		High Resolution Color Joystick,(CJSM2+BT) <i>3.5" Color LCD Display, Paddle Switches, Programmable Shortcut Keys, ICONs, Stereo Jack, IR and dual (IOS/Android) Bluetooth control</i>	\$1,167.00
250J119		Omit Remote Control <i>(Required with arm mounted specialty controls)</i>	-\$25.00
Joystick Mounting			\$
250JM34		Fixed on Armrest	NC
250JM35		Parallel Swing-Away	\$412.00
250JM36		Link-It Mid Line Mount on Armrest <i>(Swing-Away)</i>	\$412.00
Joystick Mount (Location)			\$
250HM16		Right Hand Armrest	NC
250HM17		Left Hand Armrest	NC
Display Language Selection R-net			\$
250L1		English	NC
250L3		French	NC
250L7		Spanish	NC

JOYSTICK / ELECTRONICS

OPTION	DESCRIPTION	RETAIL
--------	-------------	--------

Joystick Handle (Optional) *N/A with HD Joystick*  P. 27 \$

250JH13	Ball Handle	\$101.00
250JH14	Foam Ball Handle	\$101.00
250JH15	T-Handle	\$101.00
250JH16	Goalpost	\$101.00

Table Top Controls \$

250OG09	Table Top Control LCD Remote Control, Center Tray Mounted, Included	\$3,250.00
---------	---	------------

Electronic Programmers  P. 27 \$

250PR10	R-net PC Programmer w/ Dongle	\$652.00
---------	-------------------------------	----------

R-net Power Modules  P. 27 \$

250ER11	Power Module, R-net, 120A, Non-Expandable <i>(Only available with High Performance)</i>	NC
250ER10	Power Module, R-net, 120A, Expandable <i>((Includes Expandable Controller & Harness) (Only Available with High Performance))</i>	NC
250EX09	Expandable 120A Controller - R-net	
250EX10	Harness for 120A Expandable Controller	
250ER17	Power Module, R-net, 90A, Expandable <i>(Includes Expandable Controller & Harness)</i>	NC
250EX15	Expandable 90A Controller - R-net	
250EX16	Harness for 90A Expandable Controller	

Ctrl+5® Switchbox Options \$

250QG11	Ctrl+5 Switch Box With Free Assignable Functions	\$995.00
250QG12	Ctrl+5 Switch Box With Free Assignable Functions <i>(Multi-power only)</i>	NC

Ctrl+5 Mounting location

250EY19	Right Armrest	NC
250EY20	Left Armrest	NC
250EY21	Back Cane, Right	NC
250EY24	Back Cane, Left	NC

Ctrl+5® Switch Type  P. 27 \$

250EY22	Push Buttons	NC
250EY23	Toggle Switches	\$328.00

R-net Optional Controls / Electronics  P. 28 *Not available if LED lights and SureTrac are both selected.* \$

250DA07	Bluetooth Mouse Module, R-net	\$1,131.00
250DA08	2nd Bluetooth Mouse Module, R-net <i>(Android and Windows)</i>	\$1,131.00
250DA09	IOS Bluetooth Mouse Module, R-net <i>(Apple)</i>	\$1,131.00

R-net Programming Selection \$

Assignable Buttons

Assignable Button feature allows for modification of joystick buttons and/or Ctrl+5 Switches allowing access to various wheelchair and seating functions. When enabled, chair will be pre-programmed with seating functions assigned to buttons on the joystick. Assignments can be changed via PC Dongle.

250PM12	Include Assignable Buttons	NC
250PM13	Omit Assignable Buttons	NC

JOYSTICK / ELECTRONICS

OPTION	DESCRIPTION	RETAIL
--------	-------------	--------

R-net Programming Selection (cont'd) \$

Power Centermount Footplate Extension Option

250IE03	Include 7.5" Powered Footplate Extension for Transfer Assist <i>(Electronics programmed to allow footplates to be extended with or without legrest being raised.) Only Available with Powered Articulation</i>	\$546.00
250IE04	Omit Footplate Extension for Transfers.	NC

R-net Omni2 Options  P. 27 For Expandable Controls, choose all that apply. \$

250N14	R-net Omni2 Only Input Control Module and 3.5" LCD Display w/ Built-In Infrared and Bluetooth® Choose Mount Below	\$2,201.00
250N15	R-net Omni2 Bundled Input Control Module and 3.5" LCD Display w/ Built-In Infrared and Bluetooth® Bundled Omni2 Available w/ Switch-It Input Devices	NC

Omni2 Mount *If used w/ Standard Joystick, it must be mounted opposite side.* \$

250DS14	Link-It with Parallel Swing-Away Omni2 Mount w/Rear Mounted Interface, Right	\$644.00
250DS15	Link-It with Parallel Swing-Away Omni2 Mount w/Rear Mounted Interface, Left	\$644.00



SPECIALTY INPUT DEVICES

OPTION	DESCRIPTION	RETAIL
--------	-------------	--------

Hand Control Packages  P. 28 *Requires Standard Joystick Omit / Only one hand control device can be ordered.* \$

Proportional Input Devices

250EU14	Switch-It MicroGuide	\$4,284.00
250EU15	Switch-It MicroPilot	\$4,284.00
250EU16	Switch-It TouchDrive 2	\$4,999.00
250EU17	Switch-It VersaGuide	\$2,360.00
250EU18	Switch-It VersaGuide EZ	\$2,789.00
250EU19	All Round Joystick Standard	\$2,360.00
250EU20	All Round Joystick Light	\$2,789.00

Mounting Position (Required)

250EM04	Link-It to the Backrest <i>(Not Available w/ Omit Back Cushion Type)</i>	\$1,235.00
250EM05	Link-It to the Fixed Joystick Mount	\$384.00
250EM06	Link-It to the Parallel Swing-Away Joystick Mount	\$644.00
250EM07	Link-It to the Midline Swing-Away	\$1,365.00
250EM08	Omit Mount	NC

Mounting Platforms (Optional) *Not available w/ Link-It to Backrest*

250MG16	SunDisk Hand Tray <i>(Only available w/ MicroSeries Joysticks)</i>	\$384.00
250MG15	Bullet Hand Tray	\$384.00

Mounting Location (Required)

250IM09	Right	NC
250IM10	Left	NC

Switch Options

–	See Switch Selections <i>(Maximum 2)</i>	–
---	--	---

Head Control Packages  P. 28 *(Select headrest mount on next page)* \$

Only one head control device can be ordered.

Proportional Input Devices

250EU25	Switch-It DualPro® Proportional Head Array - Facial Pads	\$6,513.00
250EU44	Switch-It DualPro® Proportional Head Array - Facial Pads - Dedicated Mode Outer Left	\$6,513.00
250EU45	Switch-It DualPro® Proportional Head Array - Facial Pads - Dedicated Mode Outer Right	\$6,513.00
250EU46	Switch-It DualPro® Proportional Head Array - Facial Pads - Dedicated Mode & Reverse	\$6,513.00
250EU26	Switch-It DualPro® Proportional Head Array - Spot Pads	\$6,513.00
250EU27	Switch-It RIM Proportional Head Control	\$6,513.00
250EU20	Switch-It RIM Proportional Head Control	\$6,513.00

Switched Input Devices

250EU28	Switch-It 3-Switch Head Array - Short Curved Wings	\$5,679.00
250EU29	Switch-It 3-Switch Head Array - Short Straight Wings	\$5,679.00
250EU30	Switch-It 3-Switch Head Array - Long Curved Wings	\$5,679.00
250EU31	Switch-It 3-Switch Head Array - Long Straight Wings	\$5,679.00
250EU42	Switch-It 4-Switch Head Array - Long Straight Wings Only - Mode Outer Left	\$5,679.00
250EU43	Switch-It 4-Switch Head Array - Long Straight Wings Only - Mode Outer Right	\$5,679.00
250EU33	Switch-It 5-Switch Head Array - Long Straight Wings Only - Mode Outer Left	\$5,679.00
250EU47	Switch-It 5-Switch Head Array - Long Straight Wings Only - Mode Outer Right	\$5,679.00

SPECIALTY INPUT DEVICES

OPTION	DESCRIPTION	RETAIL
--------	-------------	--------

Head Control Packages (cont'd) \$

Switch Options

–	See Switch Selections (<i>Maximum 2</i>)	–
---	--	---

Sip 'N Puff \$

250ID73	Switch-It Sip 'N Puff Combo Head Array with Link-It Hardware (<i>Requires headrest mount</i>)	\$6,494.00
250ID74	Switch-It OptiStop with Sip 'N Puff	\$2,529.00

Headrest Mounts (*Applies to Head/Sip 'N Puff control packages*) \$

250IJ13	Whitmyer® Linx Headrest Mount with Quick Release	\$215.00
250IJ14	Whitmyer® Linx-2 Headrest Mount with Quick Release	\$260.00
250IJ15	Whitmyer® AXYS Headrest Mount with Quick Release	\$215.00
250IJ16	Whitmyer® AXYS Offset Headrest Mount with Quick Release	\$215.00
250IJ17	Whitmyer® Cobra FB Headrest Mount with Quick Release	\$515.00

Chin Control Packages  P. 28 \$

Proportional Input Devices

250EU34	Switch-It MicroGuide (<i>Switches mounted to the headrest only.</i>)	\$4,284.00
250EU35	Switch-It MicroPilot (<i>Switches mounted to the headrest only.</i>)	\$4,284.00
250EU36	Switch-It VersaGuide	\$2,360.00
250EU37	Switch-It VersaGuide EZ	\$2,789.00
250EU38	All Round Joystick Light - Omni2 (<i>Requires satellite twister switches.</i>)	\$2,360.00
250EU39	All Round Joystick Standard - Omni2 (<i>Requires satellite twister switches.</i>)	\$2,789.00

Mounting Position

250EM09	Link-It To Chin Harness, Small (150mm / 6")	\$1,625.00
250EM10	Link-It To Chin Harness, Large (220mm / 8")	\$1,625.00
250EM11	Link-It To Headrest, Swing-Away	\$1,625.00
250EM53	Link-It To Manual Chin Boom - Right Side	\$4,934.00
250EM54	Link-It To Manual Chin Boom - Left Side	\$4,934.00
250EM55	Link-It To Power Chin Boom - Right Side	\$8,444.00
250EM56	Link-It To Power Chin Boom - Left Side	\$8,444.00
250EM16	Omit Mount	NC

Input Device Mounting Location

250IM13	Right	NC
250IM14	Left	NC

Switch Options

–	See Switch Selections (<i>Minimum 1 for the Power Chin Boom, Maximum 3</i>)	–
---	---	---

Safety Devices \$

250SA06	Switch-It Remote Stop Switch - XLR Connector	\$1,216.00
---------	--	------------

Switched Driving Packages \$

250SW43	SJX6 Hub - 6 Powered SmartJacks for Driving, Mode and User Switch - Select Maximum 6 Switches	\$2,334.00
---------	---	------------

SPECIALTY INPUT DEVICES

OPTION	DESCRIPTION	RETAIL
--------	-------------	--------

Switches  P. 29

Single switches can be programmed to activate any function of the wheelchair including: On/Off, Mode, Profile, Speeds, Seating, Memory Positions, Horn, Lights & Indicators, IR functions, Bluetooth mouse clicks, Environmental Controls when plugged into assignable port.

Switches can connect via: Joysticks (Standard, Micro series, Versa series, All-round series) Omni2, SJX6 Hub, head controls

Switch ordering instructions:

1. Select switch type and quantity in Section "A" using columns below. (Max 6 switches. See limitations below.)
2. Select switch mounting position from Section "B" using corresponding switch column.
3. Select switch mounting location from Section "C" using corresponding switch column.

Section A – Switch Selections

Switch / Quantity

Single Function Switches - Mechanical Switches	Switch 1	Switch 2	Switch 3	Switch 4	Switch 5	Switch 6	\$
Buddy Button - Black							\$101.00
Buddy Button - Blue							\$101.00
Buddy Button - Green							\$101.00
Buddy Button - Red							\$101.00
Buddy Button - Yellow							\$101.00
Egg Switch - Black							\$101.00
Egg Switch - Blue							\$101.00
Egg Switch - Green							\$101.00
Egg Switch - Red							\$101.00
Egg Switch - Yellow							\$101.00
MicroLite (Includes color labels)							\$106.00
Mini Button 1 - Blue (Velcro)							\$284.00
Mini Button 1 - Green (Velcro)							\$284.00
Mini Button 1 - Red (Velcro)							\$284.00
Piko - Black							\$358.00
Piko - Blue							\$358.00
Piko - Green							\$358.00
Piko - Orange							\$358.00
Piko - Red							\$358.00
Piko - Yellow							\$358.00
Twister Switch - Black (Must choose mount and location)							\$228.00
Twister Switch - Green (Must choose mount and location)							\$228.00
Twister Switch - Red (Must choose mount and location)							\$228.00

Electronic Switches

Flex Switch (Headrest mount only)							\$280.00
Zero Touch Proximity Sensor							\$254.00

Section B – Switch Mounting Position

Link-It to the Backrest (Up to 1 per side)							\$845.00
Link-It to the Headrest - Gooseneck & Rigid (Up to 2 per side)							\$845.00
Link-It to the Fixed Joystick Mount (Up to 2 per side)							\$644.00
Link-It to the Parallel Swing-Away Joystick Mount (Up to 2 per side)							\$644.00
Link-It to the Seat Rail (Up to 2 per side) (Not avail w/knee & thigh supports)							\$514.00
Omit Mount (includes Velcro)							NC

Section C – Switch Mounting Location

Right side of chair							NC
Left side of chair							NC

JAY® SYNCRA™ SEATING MEASURING GUIDE

JAY® SYNCRA™ BACK



Backrest Width	16"	18"	20"	22"
Max User Trunk Width	13.5"	15.5"	17.5"	19.5"

JAY® Swing-Away Lateral Thoracic Adjustment Range

Syncra Back Width	Width Range	Height range from bottom of shell to seat pan
16"	10" to 24"	12" to 19.5"
18"	12" to 26"	12.5" to 21.5"
20"	14" to 28"	12.5" to 22"
22"	16" to 30"	13.5" to 23"

Syncra™ Fixed Lateral Support Accessory Range

Syncra Back Width	Width Range	Height range from bottom of shell to seat pan	Contour Depth Range
16"	16.4" to 16.8"	6" to 8"	3" to 5"
18"	18.4" to 18.8"	6" to 8"	3" to 5"
20"	20.4" to 20.8"	6" to 8"	3" to 5"
22"	22.4" to 22.8"	6" to 8"	3" to 5"

Syncra™ Back Shell Height Diagram

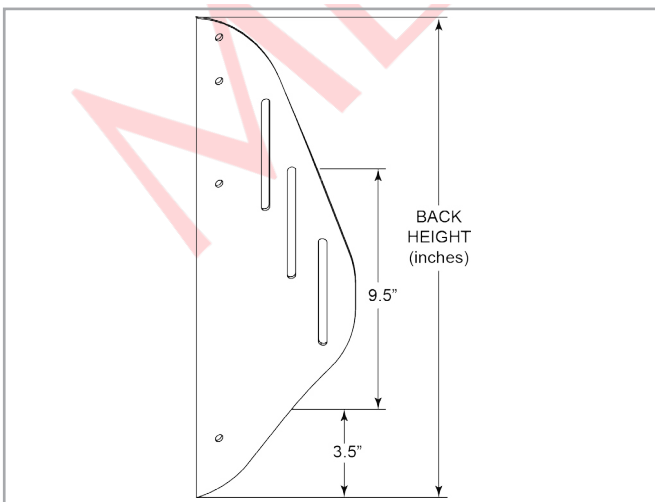

JAY® SYNCRA™ CUSHION



JAY® Lateral Thigh Support Adjustment Range

Syncra Cushion Width	Width Range
16"	8.5" to 16.0"
17"	9.5" to 17.0"
18"	10.5" to 18.0"
19"	11.5" to 19.0"
20"	12.5" to 20.0"
22"	14.5" to 22.0"

POWER BASE

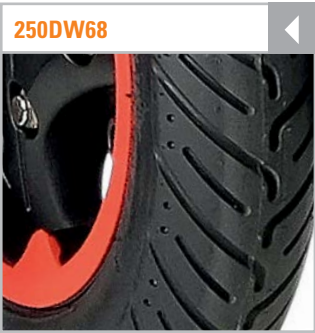

250DW68
14" Drive Wheel, Pneumatic, V-Type

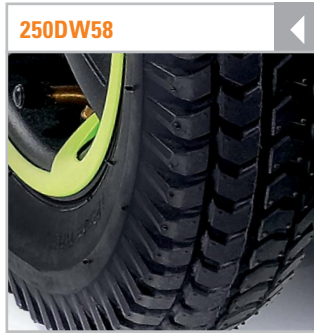

250DW58
14" Drive Wheel, Knobby



250CW55
6" Caster Wheels

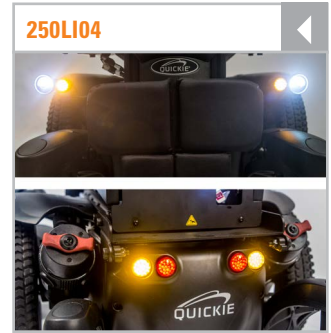

250LI04
LED Lights



250BJ28
Charger

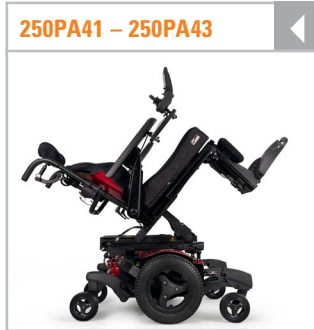

250PA41 – 250PA43
Power Seating: Tilt, Recline

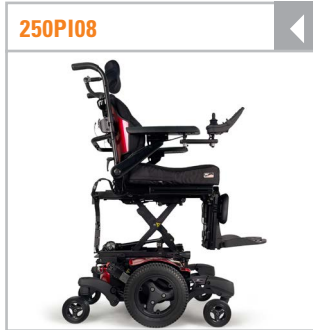

250PI08
Power Seating: Elevate

SEATING AND POSITIONING



250JP01
JAY® J3® Back: 2.2"



250JP11
JAY® J3® Back: 3"



250JP13
JAY® J3® Back: 6"

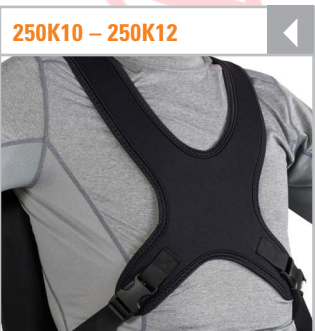

250K10 – 250K12
JAY® Anterior Thoracic Support



250JS02 – 250JS04
JAY® J3® Back, Spine-Align Kit 2

SEATING AND POSITIONING

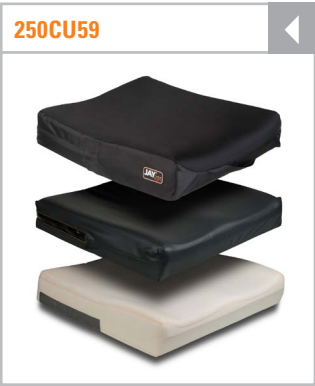

JAY® Ion® Cushion



JAY® Union® Cushion

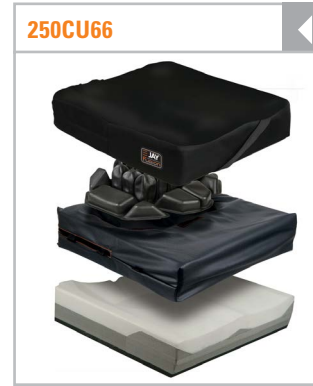

JAY® Fusion® Cushion w/Air

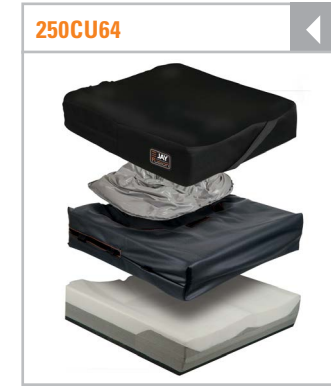

JAY® Fusion® Cushion w/Fluid

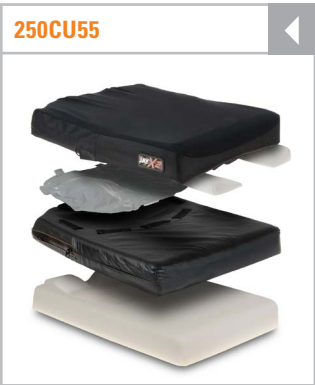

JAY® X2® Cushion



JAY® J2® Cushion



JAY® J2® Deep Contour Cushion



SEDEO® Reclining Flip Back Armrest



Comfort Reclining Armpad, Foam



SEDEO® Reclining Armrest Pad



Comfort Reclining Armpad, Gel

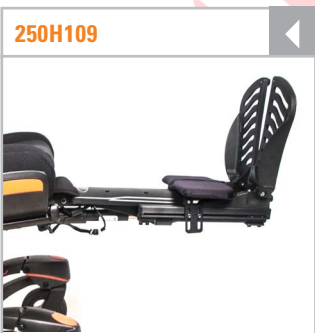

Power Centermount Legrest, Power Articulation

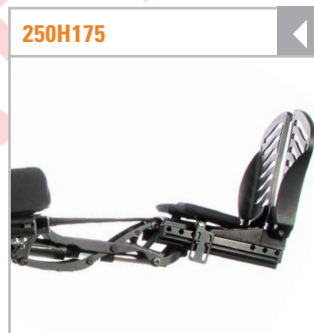

Power Centermount Legrest, Mechanical Articulation

SEATING AND POSITIONING



Positioning Belt, Aircraft Style



SEDEO® Headrest, Small



SEDEO® Headrest, Flexible

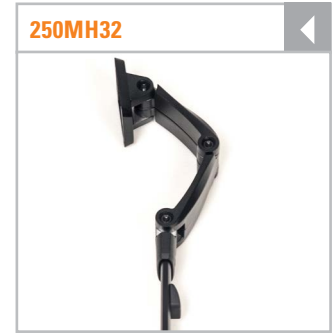

SEDEO® Multiposition Headrest Mount



Whitmyer® Plush Headrest



Whitmyer® Adjust-a-Plush Headrest

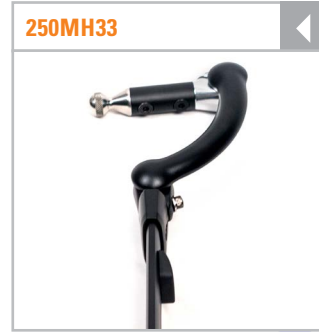

Whitmyer® Linx Headrest Mount

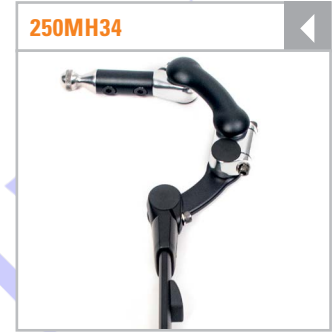

Whitmyer® Linx-2 Headrest Mount

ELECTRONICS



Color Joystick



Heavy Duty Color Joystick

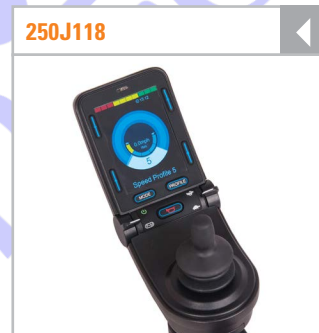

High Resolution Color Joystick, (CJSM2+BT)



Goalpost Joystick Handle



T-Handle Joystick Handle

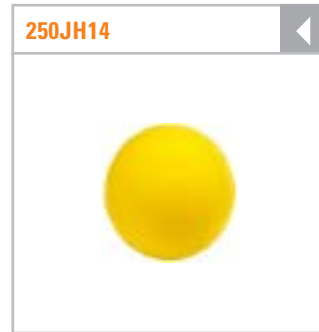

Foam Ball Joystick Handle



Ball Joystick Handle

ELECTRONICS



R-net PC Programmer



R-net Power Module



Attendant Control



Ctrl+5®, Push Button



Ctrl+5®, Toggle

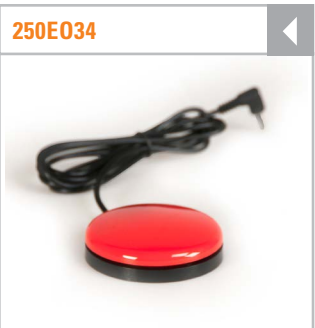

2.5" Single Switch
black, blue, green, red, yellow

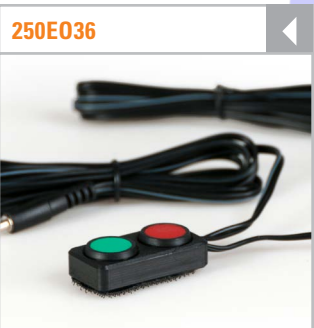

Mini 2 Button



Mini 1 Button (Mono Plug)
blue, green, red

ELECTRONICS

250EU14 & 250EU34



Switch-It™ MicroGuide

250EU15 & 250EU35



Switch-It™ MicroPilot

250EU16



Switch-It™ TouchDrive 2 (TD2)

250EU17 & 250EU36



Switch-It™ VersaGuide

250EM04



Link-It to Backrest

250EM05



Link-It to Fixed Joystick Mount

250EM06



Link-It to Parallel Swing-Away Joystick Mount

zEM07

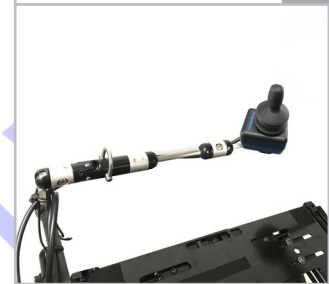

Link-It to Midline Swing-Away

250EM09



Link-It to Chin Harness

250EM11



Link-It to Headrest, Swing-Away

250EM53



Link-It to Manual Chin Boom

ELECTRONICS

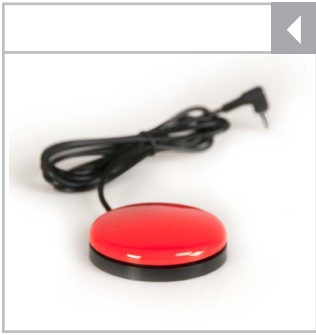

2.5" Single Switch
black, blue, green, red, yellow

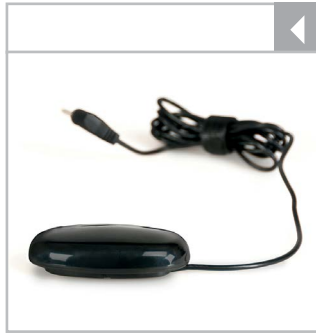

Egg Switch
black, blue, green, red, yellow



MicroLite



1" Single Switch
black, blue, green, orange, red, yellow

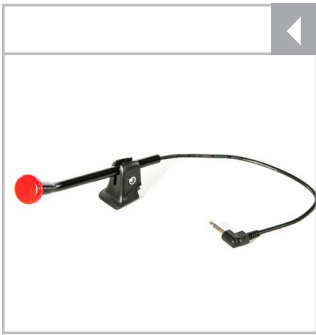

Twister Switch
black, green, red

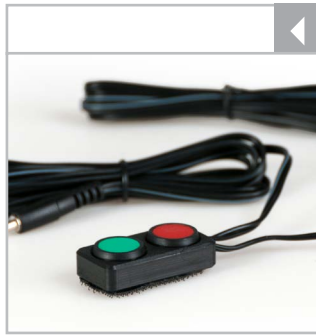

Mini 2

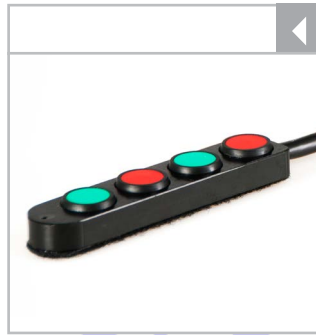

Mini 4



Mini 1 Button (Mono Plug)
blue, green, red

MEDMAGIC



Q700 M with SEDEO® LITE™		\$
Base Price		
Total of additional equipment		
Packaging and transport		
Total Price		

Date	Signature
------	-----------

Month Day Year



Customer Service: (800) 263-3390
 Fax: (800) 561-5834
 E-mail: cscanada@sunmed.com
 www.sunrisemedical.ca
 Specifications are subject to change without notice.

© 2021 Sunrise Medical Canada Inc.
 237 Romina Drive, Unit 3
 Concord, Ontario
 L4K 4V3
 MK-129632-AADL, Rev. 2