



Quickie IRIS - AADL W326P (Pediatric A Tilt-In-Space Wheelchair)

October 2024 EIZ4-2

Mark For:

Submitting for:

Quote Order

Date: _____

PO#: _____

Dealer Acct #: _____

Dealer: _____

Dealer Contact: _____

Dealer Address: _____

Dealer City: _____

Dealer Phone: _____

Confirmation Email: _____

Confirm Via: Fax Email



ADDITIONAL SHIPPING INFORMATION

Ship To: _____

Attention: _____

Address: _____

Address: _____

Ship To City: _____ PR: _____ PC: _____

Ship To Phone: () _____ Fax: () _____

Discount is 8%

Option #	Definition	Price	Option #	Definition	Price
----------	------------	-------	----------	------------	-------

1. FRAME

Base Model

<input type="checkbox"/>	183WM56	Quickie IRIS with True Fit Growth	\$4,848.00
<input type="checkbox"/>	183WM107	Quickie IRIS True Fit - Transit included	\$4,848.00

Power Tilt

Available with Heavy Duty. N/A with under mount Vent/Battery tray and Mono Back. Only available with Dual Post or Single Post Armrest styles with Desk and Full Length Classic Armrests. N/A with -5° pre tilt angle.

<input type="checkbox"/>	183PA53	Power Tilt (W/ Attendant & User Cntrl) Tilt Control mounts to armrest <input type="checkbox"/> Left <input type="checkbox"/> Right (Rear Facing)	\$3,102.00
--------------------------	---------	--	------------

Pre-Set Tilt Angle (55° range) (Default in Bold)

<input type="checkbox"/>	183TA5	-5 to 50° N/A w/ Heavy Duty and 12.5" STFH	NC
<input type="checkbox"/>	183TA6	0 to 55°	NC
<input type="checkbox"/>	183TA7	+5 to 60° N/A w/Heavy Duty Package	NC

Pre-Set Tilt Angle (40° range) (Default in Bold)

<input type="checkbox"/>	183TA8	-5 to 35° N/A w/ Heavy Duty and 12.5" STFH	NC
<input type="checkbox"/>	183TA1	0 to 40°	NC
<input type="checkbox"/>	183TA10	+5 to 45° N/A w/Heavy Duty Package	NC

Transit

<input type="checkbox"/>	183TO45	WC-19 Transit Occupied	NC
--------------------------	---------	------------------------	----

Tilt Release Options

<input type="checkbox"/>	183TT8	Foot Release - No Cables N/A w/ Power Tilt, Vent and Battery Tray, 21-22" depth and +5° set-ups. <input type="checkbox"/> Left <input type="checkbox"/> Right (Facing from rear)	NC
<input type="checkbox"/>	183TT12	Backrest Dual trigger cable releases N/A w/ Power Tilt	NC

Frame Options

<input type="checkbox"/>	183FS23	Standard Base and Seat Frame Maximum Weight: 300 lbs.	NC
<input type="checkbox"/>	183HV1	Heavy Duty Package (Max: 400lbs) N/A w/ Vent, Battery Tray and Mono Back	\$1,243.00
<input type="checkbox"/>	183FS24	Vent/Battery Tray Base N/A w/ Power Tilt, Attendant Wheel Lock, Mono Back and 14" and 15" frame width; min 17" STFH.	\$779.00
<input type="checkbox"/>	183FT46	Contracture Seat Frame N/A w/ 14" or 15" frame depths. N/A w/ drop seat pan.	NC

Frame Struts

<input type="checkbox"/>	183GY01	Fixed (Standard)	NC
<input type="checkbox"/>	183GY02	Width Adjusting System Avail. range 14"-21". Max growth 22" N/A with Mono Back	\$69.00

2. SIZE / SEATING

Frame Width

21" & 22" not available with removable stroller handle extension

<input type="checkbox"/>	183W5	14"	NC
<input type="checkbox"/>	183W6	15"	NC
<input type="checkbox"/>	183W7	16"	NC
<input type="checkbox"/>	183W8	17"	NC
<input type="checkbox"/>	183W9	18"	NC
<input type="checkbox"/>	183W10	19"	\$303.00
<input type="checkbox"/>	183W11	20"	\$303.00
<input type="checkbox"/>	183W12	21"	\$303.00
<input type="checkbox"/>	183W13	22"	\$303.00

Frame Width - Built 4 Me Options

Requires Heavy Duty package

<input type="checkbox"/>	183W57	B4ME - 23" Width	\$1,417.00
<input type="checkbox"/>	183W58	B4ME - 24" Width	\$1,417.00

Seat Type

<input type="checkbox"/>	183ST35	Standard Seat Pan For growth ranges, see Figure 1.5	\$243.00
<input type="checkbox"/>	183ST36	Drop Seat Pan - N/A w/ Power Tilt, HD, Contracture footrest system	\$173.00
<input type="checkbox"/>	183ST54	Omit Seat Pan	NC

JAY Cushions (Optional)

To order any JAY cushions on-chair, please see the JAY price list.

Cushion name or part number must be filled out with desired width and depth.

<input type="checkbox"/>	183JC20	JAY Bundled Cushion Cushion Name/Part #: Width: _____ Depth: _____	Price List
--------------------------	---------	--	------------

Made To Order Seating

<input type="checkbox"/>	183QC01	JAY AES	Order Form
<input type="checkbox"/>	183QC02	JAY Surefit	Order Form
<input type="checkbox"/>	183QC03	JAY Fit	Order Form

2. SIZE / SEATING (CONT) Fill out either A or B)

A. Setup By QUICKIE

B. Setup By DEPTH

A. User's Seated Height			
See Figure 1.2 , Dimension B. Distance from seat surface to top of the head.			
<input type="checkbox"/>	183SJ01	Less than 37"	NC
<input type="checkbox"/>	183SJ02	37" or Greater	NC

B. Frame Depth Range			
<input type="checkbox"/>	183FL91	Short Seat Frame 14"-18"	NC
<input type="checkbox"/>	183FL92	Medium Seat Frame 16"-20"	NC
<input type="checkbox"/>	183FL93	Long Seat Frame 18"-22"	NC

A. User's Weight (Default in Bold)			
<i>301-400 lb options only available w/ HD Package</i>			
<input type="checkbox"/>	183BO01	0 - 300 lbs	NC
<input type="checkbox"/>	183BO03	301 - 350 lbs	NC
<input type="checkbox"/>	183BO12	351 - 400 lbs	NC

B. Frame Depth			
<input type="checkbox"/>	183FD5	14" <i>recommend short seat frame</i>	NC
<input type="checkbox"/>	183FD6	15" <i>recommend short seat frame</i>	NC
<input type="checkbox"/>	183FD7	16" <i>recommend short seat frame</i>	NC
<input type="checkbox"/>	183FD8	17" <i>recommend short seat frame</i>	NC
<input type="checkbox"/>	183FD9	18" <i>recommend medium seat frame</i>	NC
<input type="checkbox"/>	183FD10	19" <i>recommend medium seat frame</i>	\$303.00
<input type="checkbox"/>	183FD11	20" <i>recommend long seat frame</i>	\$303.00
<input type="checkbox"/>	183FD16	21" <i>recommend long seat frame</i>	\$303.00
<input type="checkbox"/>	183FD17	22" <i>recommend long seat frame</i>	\$303.00

OR

A. Desired Seat Depth			
Figure 1.2 , Dimension A for measurement			
<input type="checkbox"/>	183SD7	14"	NC
<input type="checkbox"/>	183SD8	15"	NC
<input type="checkbox"/>	183SD9	16"	NC
<input type="checkbox"/>	183SD10	17"	NC
<input type="checkbox"/>	183SD11	18"	NC
<input type="checkbox"/>	183SD12	19"	\$303.00
<input type="checkbox"/>	183SD13	20"	\$303.00
<input type="checkbox"/>	183SD14	21"	\$303.00
<input type="checkbox"/>	183SD33	22"	\$303.00

A. Top of Cushion to Seat Rail

See **FIGURE 1.3** Dimensions A & B. This measurement is taken from the top of the cushion to the upper surface of the seat rail. If the cushion has a wedged shape and/or has significant lateral pelvic contour, then determine the height of the cushion at the point where the ischial tuberosities would contact (not immerse) the cushion surface.

<input type="checkbox"/>	183CJ01	2 1/2" or Greater	NC
<input type="checkbox"/>	183CJ02	Less than 2 1/2"	NC
<input type="checkbox"/>	183CJ03	Below Seat Rail	NC

Figure 1.4

Frame Width	Seat Pan Growth
14"	14" - 16"
15"	15" - 16"
16"	16" - 18"
17"	17" - 18"
18"	18" - 20"
19"	19" - 20"
20"	20" - 22"
21"	21" - 22"
22"	NA

Figure 1.2

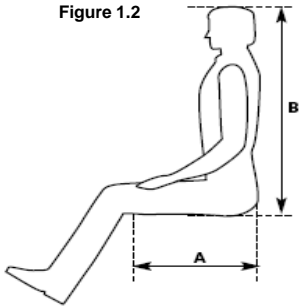
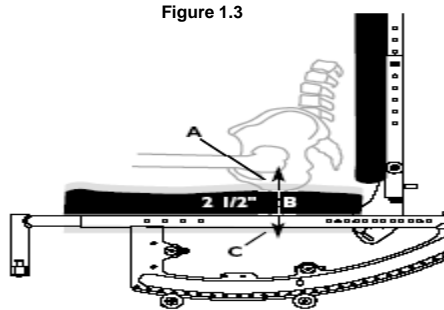

Figure 1.3



Front Seat Height

Rear Wheel Size	CASTER SIZE					
	4"	5"	6"	8x1"	8x1.5"	8x2"
12" Mag	<input type="checkbox"/> 12.5"	<input type="checkbox"/> 13.5"	<input type="checkbox"/> 16.5"		<input type="checkbox"/> 16.5"	
		<input type="checkbox"/> 16.5"	<input type="checkbox"/> 17.0"	<input type="checkbox"/> 17.0"	<input type="checkbox"/> 17.0"	
		<input type="checkbox"/> 17.0"	<input type="checkbox"/> 17.5"	<input type="checkbox"/> 17.5"	<input type="checkbox"/> 17.5"	<input type="checkbox"/> 17.0"
		<input type="checkbox"/> 17.5"		<input type="checkbox"/> 18.0"	<input type="checkbox"/> 18.0"	<input type="checkbox"/> 18.0"
12" Low Poly		<input type="checkbox"/> 16.0"	<input type="checkbox"/> 16.0"		<input type="checkbox"/> 16.0"	
		<input type="checkbox"/> 16.5"	<input type="checkbox"/> 16.5"	<input type="checkbox"/> 16.5"	<input type="checkbox"/> 16.5"	<input type="checkbox"/> 16.5"
		<input type="checkbox"/> 17.0"	<input type="checkbox"/> 17.0"	<input type="checkbox"/> 17.0"	<input type="checkbox"/> 17.0"	<input type="checkbox"/> 17.0"
		<input type="checkbox"/> 17.5"		<input type="checkbox"/> 17.5"		
16" Mag	<input type="checkbox"/> 13.5"					
	<input type="checkbox"/> 14.0"					
	<input type="checkbox"/> 14.5"	<input type="checkbox"/> 14.5"				
	<input type="checkbox"/> 15.0"	<input type="checkbox"/> 15.0"				
	<input type="checkbox"/> 18.0"	<input type="checkbox"/> 18.0"	<input type="checkbox"/> 18.0"	<input type="checkbox"/> 18.0"	<input type="checkbox"/> 18.0"	<input type="checkbox"/> 18.0"
	<input type="checkbox"/> 18.5"	<input type="checkbox"/> 18.5"	<input type="checkbox"/> 18.5"	<input type="checkbox"/> 18.5"	<input type="checkbox"/> 18.5"	
20" Mag / 5 Spoke		<input type="checkbox"/> 16.0"	<input type="checkbox"/> 16.0"		<input type="checkbox"/> 16.0"	
		<input type="checkbox"/> 16.5"	<input type="checkbox"/> 16.5"	<input type="checkbox"/> 16.5"	<input type="checkbox"/> 16.5"	<input type="checkbox"/> 16.5"
		<input type="checkbox"/> 17.0"	<input type="checkbox"/> 17.0"	<input type="checkbox"/> 17.0"	<input type="checkbox"/> 17.0"	<input type="checkbox"/> 17.0"
		<input type="checkbox"/> 17.5"		<input type="checkbox"/> 17.5"		
22" Mag / 5 Spoke		<input type="checkbox"/> 17.0"	<input type="checkbox"/> 17.0"	<input type="checkbox"/> 17.0"		<input type="checkbox"/> 17.0"
		<input type="checkbox"/> 17.5"	<input type="checkbox"/> 17.5"	<input type="checkbox"/> 17.5"	<input type="checkbox"/> 17.5"	
		<input type="checkbox"/> 18.0"	<input type="checkbox"/> 18.0"	<input type="checkbox"/> 18.0"	<input type="checkbox"/> 18.0"	<input type="checkbox"/> 18.0"
		<input type="checkbox"/> 18.5"		<input type="checkbox"/> 18.5"		
24" Mag / 5Spoke & Spoke		<input type="checkbox"/> 18.0"	<input type="checkbox"/> 18.0"		<input type="checkbox"/> 18.0"	<input type="checkbox"/> 18.0"
		<input type="checkbox"/> 18.5"	<input type="checkbox"/> 18.5"	<input type="checkbox"/> 18.5"	<input type="checkbox"/> 18.5"	
		<input type="checkbox"/> 19.0"	<input type="checkbox"/> 19.0"	<input type="checkbox"/> 19.0"	<input type="checkbox"/> 19.0"	<input type="checkbox"/> 19.0"
		<input type="checkbox"/> 19.5"		<input type="checkbox"/> 19.5"		

Castors

<input type="checkbox"/> 183CW73	4" x 1.25" Semi Pneumatic N/A w/ Heavy Duty Option	NC
<input type="checkbox"/> 183CW53	5" x 1" Polyurethane	NC
<input type="checkbox"/> 183CW7	5" x 1.5" Semi Pneumatic	\$108.00
<input type="checkbox"/> 183CW45	6" x 1" Polyurethane	NC
<input type="checkbox"/> 183CW35	6" x 1.5" Semi Pneumatic	\$108.00
<input type="checkbox"/> 183CW46	8" x 1" Polyurethane	NC
<input type="checkbox"/> 183CW39	8"x 1.5" Semi Pneumatic	\$144.00
<input type="checkbox"/> 183CW36	8"x 2" Pneumatic	\$243.00
<input type="checkbox"/> 183CW37	8"x 2" Pneumatic w/Insert	\$387.00

Axle Plate

One arm drive only available in 6 spoke Mags

<input type="checkbox"/> 183AL33	Standard Axle Plate	NC
<input type="checkbox"/> 183AL17	One Arm Drive Axle Plate N/A w/ 12" & 16" mag, 24" spoke wheels.	\$1,362.00
<input type="checkbox"/> 183OA2	One Arm Drive Standard Handrim	NC
<input type="checkbox"/> 183HM1	Right Hand Mount	NC
<input type="checkbox"/> 183HM2	Left Hand Mount	NC
<input type="checkbox"/> 183OA1	One Arm Drive Small Handrim N/A w/ 20" mag wheels	NC
<input type="checkbox"/> 183HM1	Right Hand Mount	NC
<input type="checkbox"/> 183HM2	Left Hand Mount	NC

4. WHEEL LOCKS / HUB LOCK

Wheel Lock		
<input type="checkbox"/> 183WL8	Push to Lock	NC
<input type="checkbox"/> 183WL41	Attendant Wheel Lock (Foot Lock) N/A w/ ext handles. N/A w/ one arm drive	\$88.00
<input type="checkbox"/> 183WL10	Omit Wheel Lock	NC

Rear Wheel

*12"-16" N/A w/handrims. 12" w/attendant wheel lock N/A w/ +5 - 60° tilt angle.
20"-22" Mag wheel N/A w/Projection handrims. See matrix for availability*

<input type="checkbox"/> 183RW13	12" Mag Wheel	NC
<input type="checkbox"/> 183RW14	16" Mag Wheel	NC
<input type="checkbox"/> 183RW3	20" Mag Wheel	NC
<input type="checkbox"/> 183RW8	22" Mag Wheel	NC
<input type="checkbox"/> 183RW1	24" Mag Wheel	NC
<input type="checkbox"/> 183RW51	24" Spoke Wheel	NC
<input type="checkbox"/> 183RW103	20" Mag Wheel 5 Spoke	NC
<input type="checkbox"/> 183RW104	22" Mag Wheel 5 Spoke	NC
<input type="checkbox"/> 183RW102	24" Mag Wheel 5 Spoke	NC

Rear Tire & Wheel Matrix

Tire	Rear Wheel		
	5 Spoke Mag	Spoke	Mag Wheel
Pneumatic	20,22,24	24	12,16,20,22,24
Pneumatic w/ Airless Insert	20,22,24	24	12,16,20,22,24
Full Poly	20,22,24	NA	20,22,24
Low Poly	NA	NA	12

12" = 203mm 16" = 305mm 20" = 451mm 22" = 501mm 24" = 540mm

Rear Wheel Tire

<input type="checkbox"/> 183RT3	Full Polyurethane	NC
<input type="checkbox"/> 183RT4	Low Polyurethane	NC
<input type="checkbox"/> 183RT1	Pneumatic	NC
<input type="checkbox"/> 183RT2	Pneumatic Airless Insert	\$243.00

Handrim

12" and 16" wheels not available with hand rims. See matrix for availability

<input type="checkbox"/> 183HR1	Aluminum Anodized	NC
<input type="checkbox"/> 183HR4	Plastic Coated	\$144.00
<input type="checkbox"/> 183HR7	Omit Handrim	NC

Rear Wheel & Handrim Matrix

Handrim	Rear Wheel		
	5 Spoke Mag	Spoke	Mag Wheel
Aluminum Anodized	20,22,24	24	20,22,24
Plastic Coat	20,22,24	24	20,22,24
Projection 8 Oblique	NA	NA	24

Projections

Not available on plastic coated. Only available with 24" rim MAG wheels

<input type="checkbox"/> 183HR8	8 Oblique	\$144.00
---------------------------------	-----------	----------

Axle

<input type="checkbox"/> 183AX1	Quick Release Axles N/A w/ one arm drive	NC
<input type="checkbox"/> 183AX17	Threaded Axles N/A w/ 24" spoke wheels	NC

4. WHEEL LOCKS / HUB LOCK

Hub Lock

Only available w/ 12" or 16" wheels. N/A w/ one arm drive.

<input type="checkbox"/> 183LK01	12" Hub Lock	\$160.00
<input type="checkbox"/> 183LK02	16" Hub Lock	\$160.00

Extension Handle

<input type="checkbox"/> 183EH7	6" Pair	\$72.00
---------------------------------	---------	---------

Option #	Definition	Price	Option #	Definition	Price
----------	------------	-------	----------	------------	-------

5. HANGER AND FOOTREST

Footrest (Choose ONE Option - A, B, or C)

A. Hanger Mounted Footrest			
<input type="checkbox"/>	183H140	70° Swing In/Swing Out -Front Mount	NC
<input type="checkbox"/>	183H142	80° Swing In/Swing Out -Front Mount	NC
<input type="checkbox"/>	183H158	90° Swing In/Swing Out -Front Mount	NC
<input type="checkbox"/>	183H146	70° Heavy Duty Front Mount Lift Off	\$190.00
<input type="checkbox"/>	183H132	80° Heavy Duty Front Mount Lift Off N/A w/ 4" casters	\$190.00
<input type="checkbox"/>	183H147	90° Heavy Duty Front Mount Lift Off N/A w/ 4" casters	\$190.00
<input type="checkbox"/>	183H161	Elevating Hanger - Front Mount N/A 90° footboard, some interference with casters if not tilted, 17" wide chairs & up.	\$334.00

A. Hanger Mounted Footrest Extension Tubes			
<i>N/A w/ 12.5" seat height</i>			
<input type="checkbox"/>	183E23	2" N/A w/ 90 swing away, 90 lift off hangers	\$52.00
<input type="checkbox"/>	183E24	4" N/A w/ 90 swing away, 90 lift off hangers	\$52.00

A. Hanger Mounted Footrest Footplates			
<i>Heel loop or leg strap not included, See Footplate Options Section</i>			
<input type="checkbox"/>	183F4	Kids Angle Adj Available w/ 14" to 16" frame width only	NC
<input type="checkbox"/>	183F8	Adult Angle Adj - Front Mount	\$173.00
<input type="checkbox"/>	183F7	Omit Footplate	NC

B. Extension Tube Mounted Footrests			
<i>Footrests mount to extension tubes</i>			
<input type="checkbox"/>	183H145	60° Swing In/Swing Out	NC
<input type="checkbox"/>	183H139	70° Swing In/Swing Out	NC
<input type="checkbox"/>	183H141	80° Swing In/Swing Out N/A w/ 8" casters	NC
<input type="checkbox"/>	183H160	Elevating Hanger - Ext Mount N/A w/ Platform Flip Up and Alum Angle Adj Front Mount footplates.	\$334.00
<input type="checkbox"/>	183H159	Articulating Hanger N/A w/ Platform Flip Up and Alum Angle Adj Front Mount footplates.	\$518.00

B. Extension Tube Mounted Footrests			
<input type="checkbox"/>	183E1	Short	NC
<input type="checkbox"/>	183E2	Medium N/A with 12.5" seat height	NC
<input type="checkbox"/>	183E5	Long N/A with 12.5" seat height	NC
<input type="checkbox"/>	183E16	High Mount <i>Only available with adult or kids angle adj. footplates</i>	\$96.00

B. Extension Tube Mounted Footrest Footplates			
<i>Heel loop or leg strap not included, See Footplate Options Section</i>			
<input type="checkbox"/>	183F1	Composite	NC
<input type="checkbox"/>	183F271	Composite Angle Adj-(16"-22"w)	\$173.00
<input type="checkbox"/>	183F5	Aluminum <i>Only available w/ELR</i>	NC
<input type="checkbox"/>	183F3	Adult Angle Adjustable - Ext Mount	\$173.00
<input type="checkbox"/>	183F48	Platform Flip-Up N/A w/ med ext tubes.	\$227.00
<input type="checkbox"/>	183F7	Omit Footplate and Ext. Tube	NC

Articulating / Elevating Hanger Cover			
<input type="checkbox"/>	183DI47	Neoprene Cover	\$320.00
<input type="checkbox"/>	183DI48	Gel Pad Cover	\$374.00

OR			
C. Contracture Footrest System			
<i>Multi-Adjustable Padded Hangers & Angle Adjustable Aluminum Footrests</i>			
<input type="checkbox"/>	183H26	Contracture Footrest System <i>N/A w/ drop seat pan. N/A w/ 15" frame depth</i>	\$589.00
<input type="checkbox"/>	183FP02	Outside Mount	NC
<input type="checkbox"/>	183FP01	Center Mount	NC
<i>Select Extension Height Below for Short</i>			
<input type="checkbox"/>	183E25	Short	
<input type="checkbox"/>	183EP1	10.5" Extension Height	NC
<input type="checkbox"/>	183EP2	11.0" Extension Height	NC
<input type="checkbox"/>	183EP3	11.5" Extension Height	NC
<input type="checkbox"/>	183EP4	12.0" Extension Height	NC
<input type="checkbox"/>	183EP5	12.5" Extension Height	NC
<input type="checkbox"/>	183EP6	13.0" Extension Height	NC
<i>Select Extension Height Below for Regular</i>			
<input type="checkbox"/>	183E26	Regular	
<input type="checkbox"/>	183EP5	12.5" Extension Height	NC
<input type="checkbox"/>	183EP6	13.0" Extension Height	NC
<input type="checkbox"/>	183EP7	13.5" Extension Height	NC
<input type="checkbox"/>	183EP8	14.0" Extension Height	NC
<input type="checkbox"/>	183EP9	14.5" Extension Height	NC
<input type="checkbox"/>	183EP10	15.0" Extension Height	NC

OR			
Z-finity Hangers/Footrest System			
<i>(Maximum weight capacity for Z-Finity footrests is 165 lbs)</i>			
<i>Some interference may exist in certain configurations.</i>			
<input type="checkbox"/>	183H162	Z-finity Hanger	NC
Z-finity Footrest Mount			
<input type="checkbox"/>	183DI22	Direct Hanger Mt/Fixed Frame - High	NC
<input type="checkbox"/>	183DI23	Direct Hanger Mt/Fixed Frame - Low	NC
<input type="checkbox"/>	183DI24	Extension Tube Mount	NC
Z-finity Footrest Pivot Arm			
<input type="checkbox"/>	183DI20	Short 2"	NC
<input type="checkbox"/>	183DI21	Long 3 1/4"	NC
Z-finity Footplate			
<i>Some interference may exist in certain configurations.</i>			
<input type="checkbox"/>	183F320	Multi Angle Adjustable (Pair) (not avail. w/8"-9" widths)	\$243.00
<input type="checkbox"/>	183F321	Angle Adjustable Platform Footboard	\$228.00
<input type="checkbox"/>	183F6	Omit Footplate	NC
Z-finity Extension Tube Length (When Choosing Ext. Tube Mount)			
<input type="checkbox"/>	183E62	Hemi Short	NC
<input type="checkbox"/>	183E1	Short	NC
<input type="checkbox"/>	183E2	Medium	NC
<input type="checkbox"/>	183E5	Long	NC

Additional Hanger and Footplate Options			
Hanger Mounts			
<i>1" Offset N/A with -5-50° and -5-35° preset tilt angle and possible interference with 80° & 90° hangers</i>			
<input type="checkbox"/>	183MZ02	Standard Hanger Mount	NC
<input type="checkbox"/>	183MZ01	1" Offset Hanger Mount	NC

Footrest Options			
<input type="checkbox"/>	183HL1	Heel Loop	NC
<input type="checkbox"/>	183HL5	Leg Strap	NC
<input type="checkbox"/>	183IG2	Impact Guard Neoprene <i>Only available w/ 60° or 70° ext. mount hanger</i>	\$60.00
<input type="checkbox"/>	183H32	Omit Hanger	NC
<input type="checkbox"/>	183HL4	Omit Heel Loop	NC
<input type="checkbox"/>	183HL6	Omit Single Leg Strap	NC

Option #	Definition	Price	Option #	Definition	Price
5. HANGER AND FOOTREST (CONT)					
JAY FOOT BOXES			JAY FOOT BOXES (cont)		
<i>Only available with Swing Away, Lift-off Hangers, Adult Angle Adj Footplates and ELR / ALR. Single Foot Box pairs N/A with 14"-15" frame widths. Full Foot Boxes N/A with Heel Loop or Leg Strap, Tall Height Full Footbox w/ 14"-15" frame width and ELR / ALR. Full Foot Box not available with 23"-24" widths.</i>					
Single Foot Box					
<input type="checkbox"/>	183JX01	Standard Height - Left			\$262.00
<input type="checkbox"/>	183JX02	Tall Height - Left			\$298.00
<input type="checkbox"/>	183JX03	Standard Height - Right			\$262.00
<input type="checkbox"/>	183JX04	Tall Height - Right			\$298.00
<input type="checkbox"/>	183JX05	Standard Height - Pair			\$525.00
<input type="checkbox"/>	183JX06	Tall Height - Pair			\$555.00
OR					
<input type="checkbox"/>	183JX07	Full Foot box Std Height			\$525.00
<input type="checkbox"/>	183JX08	Full Foot box Tall Height			\$595.00
<input type="checkbox"/>	183JX09	Full Foot box w/ Divider Std Ht			\$525.00
<input type="checkbox"/>	183JX10	Full Foot box w/ Divider Tall Ht			\$595.00

6. BACKREST / SEATING							
Dynamic Backrest			JAY J3 Back				
<input type="checkbox"/>	183BT101	Dynamic Backrest N/A w/ Reclining Backrest or 21"- 22" seat depth. N/A w/ Heavy D.	21"	<input type="checkbox"/>	183JB01	JAY J3 Back N/A w/ O2 Holder	See OF
Built 4 Me Options							
<input type="checkbox"/>	183VU18	B4ME - Dynamic Back w/19" Depth				\$809.00	
<input type="checkbox"/>	183VU19	B4ME - Dynamic Back w/20" Depth				\$809.00	

Backpost Style - (Choose ONE Option - A, B, C, or D)					
A. Stroller Handle Backpost (Fixed)			OR		
<input type="checkbox"/>	183BP9	Low (18")			NC
<input type="checkbox"/>	183BP10	Medium (21")			NC
<input type="checkbox"/>	183BP11	Tall (24")			NC
<input type="checkbox"/>	183BP13	Removable Extension N/A w/ 21"-22" frame width, height adj back with adj stroller handles			\$173.00
OR					
B. Height Adjustable Back w/ Adj. Stroller Handles					
Select desired Push Handle					
<input type="checkbox"/>	183PH8	Standard Push Handle			NC
<input type="checkbox"/>	183PH9	Long Push Handle Recommended in combo w/ vent & battery tray			NC
AND select desired Back Cane					
<input type="checkbox"/>	183B200	Standard 15"-21"			NC
<input type="checkbox"/>	183B201	Tall 18"-24"			NC
OR					
C. Reclining Backrest (0-40°)					
<i>Only available with 40 degree tilt range. N/A w/ 22" Deep Frame.</i>					
<input type="checkbox"/>	183BT21	Reclining Backrest			\$1,547.00
<input type="checkbox"/>	183BP64	Angle Adj stroller handles Height adj range 19"- 23"			\$204.00
<input type="checkbox"/>	183B5	Medium			NC
<input type="checkbox"/>	183B9	Tall			NC
<input type="checkbox"/>	183PH8	Standard push handle			NC
<input type="checkbox"/>	183PH9	Long push handle			NC
OR					
D. Mono Back System					
<i>Must select JAY J3 or JAY personalized Back when ordering Mono Back System.</i>					
Select One					
<input type="checkbox"/>	183MO1	Mono Backrest System			\$600.00
<input type="checkbox"/>	183MO2	Mono Backrest System w/Dynamic Backrest			\$1,867.00
AND Select desired Push Handle					
<input type="checkbox"/>	183PH8	Standard Push Handle			NC
<input type="checkbox"/>	183PH9	Long Push Handle			NC

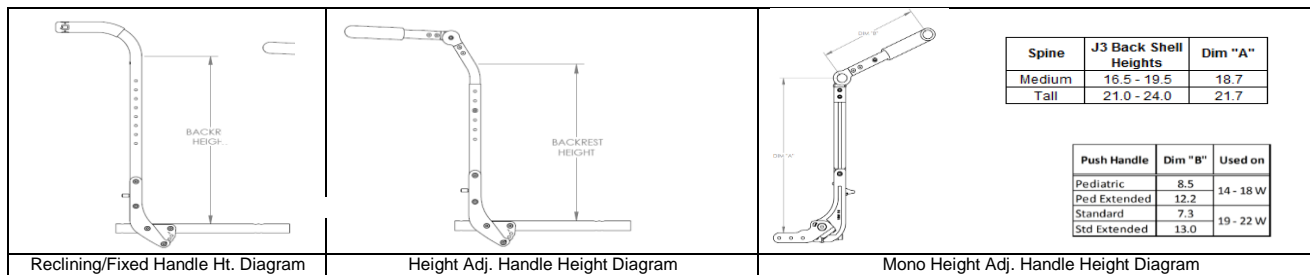

Backrest Position (set up by Quickie)			
<i>See FIGURE 1.5. The location of the backrest surface in relation to the front of the backpost. The measurement is taken from the front surface of the backpost to the deepest area of the backrest in contact with the user's body.</i>			
<input type="checkbox"/>	183BQ01	+3"	NC
<input type="checkbox"/>	183BQ05	+2"	NC
<input type="checkbox"/>	183BQ02	+1"	NC
<input type="checkbox"/>	183BQ03	Flush	NC
<input type="checkbox"/>	183BQ04	-1"	NC
<input type="checkbox"/>	183BQ06	-2"	NC

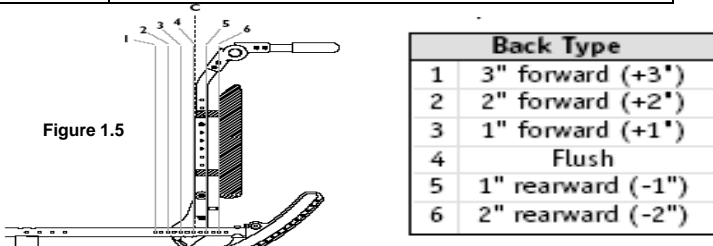

✓	Option #	Definition	Price	✓	Option #	Definition	Price
6. BACKREST / SEATING (CONT)							

Mono Backrest Options ONLY

N/A on HD, Vent/Battery Tray Base(LTV only), Reclining Backrest, Desk Length Armpads and Canopy.

JAY J3 Back for Mono Backrest System

<input type="checkbox"/>	183JB04	JAY J3 Back Mono	See OF
<input type="checkbox"/>	183JB05	JAY J3 via JAY Your Way	See OF
JAY J3 Backrest Contour			
<input type="checkbox"/>	183JP01	J3 PA Back (2.2" of Contour Depth) 14"-20" Wide	\$909.00
<input type="checkbox"/>	183JP02	J3 PA Back (2.2" of Contour Depth) 22" Wide	\$1,966.00
<input type="checkbox"/>	183JP03	J3 PL Back (3.0" of Contour Depth) 14"-20" Wide	\$982.00
<input type="checkbox"/>	183JP04	J3 PDL Back (6.0" of Contour Depth) 14"-20" Wide	\$1,054.00
<input type="checkbox"/>	183JP05	J3 PDC Back (6.0" of Contour Depth) 14"-20" Wide	\$1,064.00

JAY J3 Backrest Height

<input type="checkbox"/>	183JR07	UT Standard 16.5" shell height	NC
<input type="checkbox"/>	183JR08	UT Medium 18" shell height	NC
<input type="checkbox"/>	183JR09	UT Tall 19.5" shell height	NC
<input type="checkbox"/>	183JR10	SH Standard 21" Shell Height	NC
<input type="checkbox"/>	183JR11	SH Medium 22.5"	NC
<input type="checkbox"/>	183JR12	SH Tall 24"	NC

JAY J3 Backrest Width

Some interference with armrest may exist when ordering a Backrest with greater than 4" wider than the base.

<input type="checkbox"/>	183JQ06	12" Backrest Width	NC
<input type="checkbox"/>	183JQ01	14" Backrest Width	NC
<input type="checkbox"/>	183JQ02	16" Backrest Width	NC
<input type="checkbox"/>	183JQ03	18" Backrest Width	NC
<input type="checkbox"/>	183JQ04	20" Backrest Width	NC

JAY J3 Backrest Color

<input type="checkbox"/>	183GZ01	Black	NC
<input type="checkbox"/>	183GZ02	Matching Frame- Standard Colors	NC
<input type="checkbox"/>	183GZ03	Matching Frame- Personalized Color	\$76.00

JAY J3 Back for Mono Backrest System Cont.

Select desired Headrest Mount (optional)			
<input type="checkbox"/>	183MH10	Axys Mount & Bracket	\$357.00
<input type="checkbox"/>	183MH15	Cobra Flip Back Mount and Bracket	\$654.00
<input type="checkbox"/>	183MH16	Onyx Mount and Bracket	\$268.00
<input type="checkbox"/>	183MH17	Omit	NC

Select desired Headrest Pad (optional)

<input type="checkbox"/>	183HE65	Plush Head Support Pad 8"	\$268.00
<input type="checkbox"/>	183HE66	Plush Head Support Pad 10"	\$268.00
<input type="checkbox"/>	183HE78	Plush Head Support Pad 14"	\$268.00
<input type="checkbox"/>	183HE87	HeadsUp Lrg: 5.3" Lng Arms	\$357.00
<input type="checkbox"/>	183HE88	HeadsUp Med: 4.1" Sht Arms	\$357.00
<input type="checkbox"/>	183HE89	HeadsUp Sml: 3.5" Sht Arms	\$357.00
<input type="checkbox"/>	183HE83	Adjust-A-Plush Standard	\$277.00
<input type="checkbox"/>	183HE82	Adjust-A-Plush Narrow	\$277.00

Select desired Lateral (optional)

<input type="checkbox"/>	LAT 4X4 S/A MOUNTS includes 1" OFFSET - PR		\$783.00
	183ZV14	LATERAL 4X4 W/ 1" OFFSET - PAIR	\$463.00
	183ZS07	LATERAL SWING AWAY MOUNT - PAIR	\$320.00
<input type="checkbox"/>	LAT 4X5 S/A MOUNTS includes 1" OFFSET - PR		\$783.00
	183ZV15	LATERAL 4X5 W/ 1" OFFSET - PAIR	\$463.00
	183ZS07	LATERAL SWING AWAY MOUNT - PAIR	\$320.00
<input type="checkbox"/>	LAT 4X6 S/A MOUNTS includes 1" OFFSET - PR		\$783.00
	183ZV16	LATERAL 4X6 W/ 1" OFFSET - PAIR	\$463.00
	183ZS07	LATERAL SWING AWAY MOUNT - PAIR	\$320.00
<input type="checkbox"/>	LAT 6X4 S/A MOUNTS includes 1" OFFSET - PR		\$783.00
	183ZV17	LATERAL 6X4 W/ 1" OFFSET - PAIR	\$463.00
	183ZS07	LATERAL SWING AWAY MOUNT - PAIR	\$320.00
<input type="checkbox"/>	LAT 6X5 S/A MOUNTS includes 1" OFFSET - PR		\$783.00
	183ZV18	LATERAL 6X5 W/ 1" OFFSET - PAIR	\$463.00
	183ZS07	LATERAL SWING AWAY MOUNT - PAIR	\$320.00
<input type="checkbox"/>	LAT 6X6 S/A MOUNTS includes 1" OFFSET - PR		\$783.00
	183ZV19	LATERAL 6X6 W/ 1" OFFSET - PAIR	\$463.00
	183ZS07	LATERAL SWING AWAY MOUNT - PAIR	\$320.00

7. ARMREST / SIDE GUARDS

Armrest

Heavy Duty Option only available w/ Dual Post Armrest. Power tilt option is only available with Dual Post or Single Post Armrest styles.

<input type="checkbox"/>	183AA63	Dual Post Height Adjustable	\$357.00
<input type="checkbox"/>	183AA43	Dual Post Flip Back	\$166.00
<input type="checkbox"/>	183AA62	Dual Post	NC
<input type="checkbox"/>	183AA48	Dual Post Flip Back Height Adj	\$334.00
<input type="checkbox"/>	183AA11	Single Post Height Adjustable - Std	\$334.00
<input type="checkbox"/>	183AA29	Single Post Height Adjustable - Low	\$334.00
<input type="checkbox"/>	183AA7	Length Adjustable Locking Flip-Up N/A w/ Contour Armpad	\$334.00
<input type="checkbox"/>	183AA1	Adjustable Locking Flip-Up	\$334.00
<input type="checkbox"/>	183AA154	Height Adj. Cantilever Armrest Available with Mono Back only. N/A w/ 20", 22" and 24" rear wheels.	\$303.00
<input type="checkbox"/>	183AA14	Omit Armrest	NC

Armrest Receiver (Single Post Height Adjustable Only)

<input type="checkbox"/>	183AR17	Low	NC
<input type="checkbox"/>	183AR18	Std	NC

Armpad

Ergo armpad only available with Single post Height adj armrest. Power tilt option is only available with Desk and Full Length Classic style.

<input type="checkbox"/>	183AM23	Desk Length Classic	NC
<input type="checkbox"/>	183AM21	Desk Length Contour	NC
<input type="checkbox"/>	183AM24	Full Length Classic	NC
<input type="checkbox"/>	183AM22	Full Length Contour	NC
<input type="checkbox"/>	183AM9	Foam Short <i>Option for Length Adj</i> Locking Flip Up	NC
<input type="checkbox"/>	183AM10	Foam Long <i>Option for Length Adj</i> Locking Flip Up	NC
<input type="checkbox"/>	183AM27	Ergo armpad	NC

Side Guard

Only available w/ length adj locking flip-up and adj locking flip-up armrest styles. N/A w/ Mono Back.

<input type="checkbox"/>	183SG3	Plastic Regular	\$185.00
<input type="checkbox"/>	183SG4	Plastic Kids	\$185.00

Option #	Definition	Price	Option #	Definition	Price
----------	------------	-------	----------	------------	-------

7. ARMREST / SIDE GUARDS (CONT)

JAY Arm Troughs

NA with Length Adj. Locking Flip Up and Adj Locking Flip Up armrests.
 Full Length Classic Armpads will automatically be selected when choosing only one side Arm Trough.

<input type="checkbox"/>	183JL01	Arm Trough - 14" long - Left	\$181.00
<input type="checkbox"/>	183JL04	Arm Trough - 14" long - Right	\$181.00
<input type="checkbox"/>	183JL05	Arm Trough - 14" long - Pair	\$362.00
<input type="checkbox"/>	183JL02	Arm Trough - 18" long - Left	\$181.00
<input type="checkbox"/>	183JL06	Arm Trough - 18" long - Right	\$181.00
<input type="checkbox"/>	183JL07	Arm Trough - 18" long - Pair	\$362.00
<input type="checkbox"/>	183JL03	Arm Trough - 22" long - Left	\$181.00
<input type="checkbox"/>	183JL08	Arm Trough - 22" long - Right	\$181.00
<input type="checkbox"/>	183JL09	Arm Trough - 22" long - Pair	\$362.00

JAY Arm Trough - Hardware

<input type="checkbox"/>	183JN01	Fixed (EA)	NC
<input type="checkbox"/>	183JN03	Fixed (Pair)	NC
<input type="checkbox"/>	183JN02	Swing Away - Rotational (EA)	\$286.00
<input type="checkbox"/>	183JN04	Swing Away - Rotational (Pair)	\$566.00

Armrest Matrix for Single Post					
Armrest Size	Transfer Tube Length D	Receiver	Classic Pad		
			H Range	Pad length L	
Std	8"	Std	10-3/4" to 15-3/4"	10-1/4"	14"
			Low		
Low	5-1/4"	Std	9" to 13"	10-1/2"	14-1/4"
			Low		
Contour Pad					
Armrest Size	Transfer Tube Length D	Receiver	H Range	Pad length L	
			Desk	Full	
Std	8"	Std	10" to 15"	10-1/2"	14-1/4"
			Low		
Low	5-1/4"	Std	8-1/2" to 12-1/2"	10-1/2"	14-1/4"
			Low		
Ergo Pad					
Armrest Size	Transfer Tube Length D	Receiver	H Range	Pad length L	
			Desk	Full	
Std	8"	Std	10-1/2" to 15-1/2"	11-3/4"	14-1/4"
			Low		
Low	5-1/4"	Std	9" to 13"	11-3/4"	14-1/4"
			Low		

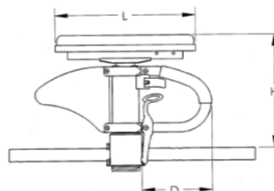

8. KEY OPTIONS AND ACCESSORIES

Anti Tips

Included with vent tray option. Not ordered as separate line item.

<input type="checkbox"/>	183AT1	Anti Tips (Pair)	\$119.00
--------------------------	--------	------------------	----------

Positioning Belt

<input type="checkbox"/>	183ZZ25	JAY 2PT Belt 2" Push Btn No Pad	\$63.00
<input type="checkbox"/>	183ZZ26	JAY 2PT Belt 2" Push Btn 9.5" Pad	\$124.00
<input type="checkbox"/>	183ZZ27	JAY 2PT Belt 1.5" Push Btn No Pad	\$63.00
<input type="checkbox"/>	183ZZ28	JAY 2PT Belt 1.5" Push Btn 7.5" Pad	\$124.00
<input type="checkbox"/>	183A117	2" Aircraft Buckle w/Clamps	\$137.00
<input type="checkbox"/>	183A118	2" Aircraft Buckle Pad w/Clamp	\$201.00
<input type="checkbox"/>	183A120	Positioning Belt Clamps Only	\$60.00

Spoke Guards

N/A with 12" and 16" mag, 5 spoke Mag wheels or projection handrims.

<input type="checkbox"/>	183A24	Clear	\$155.00
<input type="checkbox"/>	183A23	Black	\$155.00

Wheelchair Tray Table

Only available if armrests are included. N/A with JAY Arm Troughs. Tray size availability will vary based on armrest style, see configurator for details.

<input type="checkbox"/>	183A30	Small (13"-14")	\$375.00
<input type="checkbox"/>	183A31	Medium (15"-17")	\$375.00
<input type="checkbox"/>	183A32	Large (18"-20")	\$375.00
<input type="checkbox"/>	183A33	X-Large (21"-22")	\$375.00

Vent Tray - Back Cane Mount

Utility hook has weight a limit of 15 lbs.

<input type="checkbox"/>	183LF12	Dovetail Vertical Frame Mounted Hardware for LTV Ventilators includes 1 utility hook	\$514.00
<input type="checkbox"/>	183LF13	Dovetail Vertical Frame Mounted Hardware for Trilogy Ventilators includes 1 utility hook	\$514.00

JAY Positioning

<input type="checkbox"/>	183K1	JAY Lower Extremity S/A support <input type="checkbox"/> Left <input type="checkbox"/> Right Position	\$538.00
<input type="checkbox"/>	183K2	Omit Hanger <input type="checkbox"/> Left <input type="checkbox"/> Right	NC
<input type="checkbox"/>	183K7	Pad Size <input type="checkbox"/> 6" x 8" <input type="checkbox"/> 8" x 10"	NC

JAY Anterior Thoracic Support

Style

<input type="checkbox"/>	183JY01	Classic Dynamic	\$241.00
<input type="checkbox"/>	183JY02	Classic Structure	\$241.00
<input type="checkbox"/>	183JY03	Contour Dynamic	\$241.00
<input type="checkbox"/>	183JY04	Contour Structure	\$241.00
<input type="checkbox"/>	183JY05	Center Opening with Buckle	\$241.00

Size

<input type="checkbox"/>	183JZ01	Small	NC
<input type="checkbox"/>	183JZ02	Medium	NC
<input type="checkbox"/>	183JZ03	Large	NC
<input type="checkbox"/>	183JZ04	X-Large	NC

JAY Padded Trunk Strap

<input type="checkbox"/>	183JA01	Padded Trunk Strap - Small	\$241.00
<input type="checkbox"/>	183JA02	Padded Trunk Strap - Medium	\$241.00
<input type="checkbox"/>	183JA03	Padded Trunk Strap - Large	\$241.00
<input type="checkbox"/>	183JA04	Padded Trunk Strap - XL	\$241.00

Miscellaneous Accessories

<input type="checkbox"/>	183A1	Black Utility Backpack	\$110.00
<input type="checkbox"/>	183A8	Black Seat Pouch	\$82.00
<input type="checkbox"/>	183A54	Extra Leg Strap Black	\$60.00
<input type="checkbox"/>	183A82	Caddy <i>Only available w/ extention tube mounted footrests</i>	\$88.00
<input type="checkbox"/>	183A601	O2 Holder <i>N/A w/ Height Adj Stroller Handles. N/A w/ Reclining Backrest, Mono Back</i>	\$422.00
<input type="checkbox"/>	183A701	IV Pole <i>N/A w/ Mono Back</i>	\$215.00
<input type="checkbox"/>	183A999	Quickie Water Bottle & Holder	\$80.00

Canopy (SunShade)

Need 2" back post clearance to mount canopy hardware. May require next height based on seating. Some interference may occur with some height configurations. N/A with Mono Back.

<input type="checkbox"/>	1838A06	Canopy (Sunshade) 10" - 14" wide	\$422.00
<input type="checkbox"/>	1838A07	Canopy (Sunshade) 15" - 20" wide	\$422.00

Hanger Options

*Aluminum material. This option comes uninstalled.
 Note: During swing In/Out process may wear out the paint on the frame over time.*

<input type="checkbox"/>	183IE05	Enhanced hanger latch	\$77.00
--------------------------	---------	-----------------------	---------

Option #	Definition	Price	Option #	Definition	Price
9. COLOR					

Standard Frame Color							
<input type="checkbox"/>	183C211	Celestial Sapphire	NC	<input type="checkbox"/>	183C221	Red Pepper	NC
<input type="checkbox"/>	183C212	Desert Sage	NC	<input type="checkbox"/>	183C222	Royal Blue	NC
<input type="checkbox"/>	183C213	Desert Tan	NC	<input type="checkbox"/>	183C223	Salute Green	NC
<input type="checkbox"/>	183C214	Gloss Black	NC	<input type="checkbox"/>	183C224	Scarlet Noir	NC
<input type="checkbox"/>	183C215	Matte Black	NC	<input type="checkbox"/>	183C225	Silver Ore	NC
<input type="checkbox"/>	183C216	Metallic Shadow	NC	<input type="checkbox"/>	183C226	Solar Orange	NC
<input type="checkbox"/>	183C217	Midnight Blue	NC	<input type="checkbox"/>	183C227	Starlight White	NC
<input type="checkbox"/>	183C218	Mystic Purple	NC	<input type="checkbox"/>	183C228	Storm Gray	NC
<input type="checkbox"/>	183C219	Petal Pink	NC	<input type="checkbox"/>	183C229	Turbo Green	NC
<input type="checkbox"/>	183C220	Pink Power	NC	<input type="checkbox"/>	183C230	velocity Yellow	NC

Personalized Frame Color			
<input type="checkbox"/>	183C112	Desert Camouflage	\$363.00
<input type="checkbox"/>	183C43	Mossy Oak Camouflage	\$363.00
<input type="checkbox"/>	183C42	Stars & Stripes	\$363.00
<input type="checkbox"/>	183C108	Zebra (Choose base color) N/A w/ Gloss Black and Matte Black.	\$363.00

Additional Options Through Built for Me

To inquire about any unique personalized Quickie products, contact: Phone: (800) 263-3390, Email: cscanada@sunmed.com



Commonly Requested Options Include:

- ✓ Frog Legs
- ✓ Longer Wheel Lock Extensions
- ✓ Reverse Configuration
- ✓ Dual Mount Wheel Locks - Attendant Foot Lock

10. APPENDIX

Lower Leg Length Matrix

Front seat height must be at least 2" taller than lower leg length on all swing in/out hangers. Front seat height must be at least 2" taller than maximum lower leg length on all front mount hangers.

Hanger	Extension	Seat Pan to Top of Footrest		Min Allowable FSH
		Min	Max	
70° Front Mount	No Ext	3 1/2	9	11 1/2
	2"	3 1/2	11 1/2	13 1/2
	4"	3 1/2	13 1/2	15 1/2
80° Front Mount	No Ext	3 1/2	9 1/2	11 1/2
	2"	3 1/2	12	14
	4"	3 1/2	14	16
90° Front Mount	No Ext	3	9	11 1/2
ELR Front Mount	No Ext	3	7	10 1/2
60° Swing In/Out	Short	9	12 1/2	12 1/2
	Med	9	14 1/2	12 1/2
	Long	11 1/2	16	14 1/2
70° Swing In/Out	Short	10 1/2	15 1/2	12 1/2
	Med	10 1/2	17 1/2	13
	Long	13 1/2	19	15
80° Swing In/Out	Short	11	14 1/2	13
	Med	11	16 1/2	13
	Long	13	18	15
ALR	Short	8 1/2	15	10 1/2
	Med	10	17	12
	Long	12	19	14
ELR Ext. Mount	Short	8	14 1/2	10
	Medium	9 1/2	16 1/2	11 1/2
	Long	11 1/2	18 1/2	13 1/2

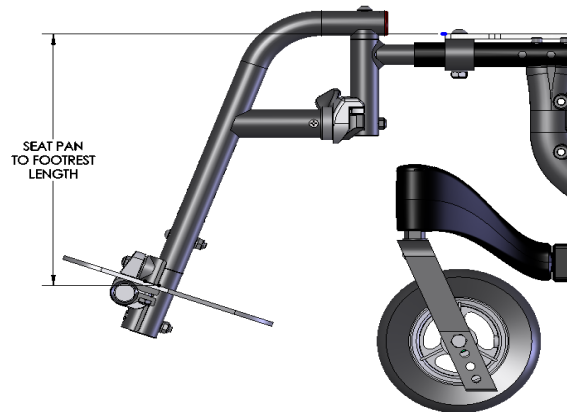



JAY® Signature Series Backrest and Accessories

Note: Not all sizes and configurations shown below, for full offering visit www.sunrisemedical.ca

When ordering mark the part number desired and it will be added to the order as a separate line item .

JAY BACKREST

JAY J3 Posterior (PA) BACK - 2.2" Contour Depth

	Shell Height	Shell Width										
		12"		14"		16"		18"		20"		
Mid Thoracic (MT)	12.0" (S)	J3PAMTSxxFS	<input type="checkbox"/>	\$875	<input type="checkbox"/>	\$875	<input type="checkbox"/>	\$875	<input type="checkbox"/>	\$875	<input type="checkbox"/>	\$875
		J3PAMTSxxTH	<input type="checkbox"/>	\$875	<input type="checkbox"/>	\$875	<input type="checkbox"/>	\$875	<input type="checkbox"/>	\$875	<input type="checkbox"/>	\$875
Upper Thoracic (UT)	16.5" (S)	J3PAUTSxxFS	<input type="checkbox"/>	\$976	<input type="checkbox"/>	\$976	<input type="checkbox"/>	\$976	<input type="checkbox"/>	\$976	<input type="checkbox"/>	\$976
		J3PAUTSxxTH	<input type="checkbox"/>	\$976	<input type="checkbox"/>	\$976	<input type="checkbox"/>	\$976	<input type="checkbox"/>	\$976	<input type="checkbox"/>	\$976
	18.0" (M)	J3PAUTMxxFS	<input type="checkbox"/>	\$976	<input type="checkbox"/>	\$976	<input type="checkbox"/>	\$976	<input type="checkbox"/>	\$976	<input type="checkbox"/>	\$976
		J3PAUTMxxTH	<input type="checkbox"/>	\$976	<input type="checkbox"/>	\$976	<input type="checkbox"/>	\$976	<input type="checkbox"/>	\$976	<input type="checkbox"/>	\$976
	19.5" (T)	J3PAUTTxxFS	<input type="checkbox"/>	\$976	<input type="checkbox"/>	\$976	<input type="checkbox"/>	\$976	<input type="checkbox"/>	\$976	<input type="checkbox"/>	\$976
		J3PAUTTxxTH	<input type="checkbox"/>	\$976	<input type="checkbox"/>	\$976	<input type="checkbox"/>	\$976	<input type="checkbox"/>	\$976	<input type="checkbox"/>	\$976
Shoulder Height (SH)	21.0" (S)	J3PASHSxxFS	<input type="checkbox"/>	\$1,006	<input type="checkbox"/>	\$1,006	<input type="checkbox"/>	\$1,006	<input type="checkbox"/>	\$1,006	<input type="checkbox"/>	\$1,006
		J3PASHSxxTH	<input type="checkbox"/>	\$1,006	<input type="checkbox"/>	\$1,006	<input type="checkbox"/>	\$1,006	<input type="checkbox"/>	\$1,006	<input type="checkbox"/>	\$1,006
	22.5" (M)	J3PASHMxxFS	<input type="checkbox"/>	\$1,006	<input type="checkbox"/>	\$1,006	<input type="checkbox"/>	\$1,006	<input type="checkbox"/>	\$1,006	<input type="checkbox"/>	\$1,006
		J3PASHMxxTH	<input type="checkbox"/>	\$1,006	<input type="checkbox"/>	\$1,006	<input type="checkbox"/>	\$1,006	<input type="checkbox"/>	\$1,006	<input type="checkbox"/>	\$1,006
	24.0" (T)	J3PASHTxxFS	<input type="checkbox"/>	\$1,006	<input type="checkbox"/>	\$1,006	<input type="checkbox"/>	\$1,006	<input type="checkbox"/>	\$1,006	<input type="checkbox"/>	\$1,006
		J3PASHTxxTH	<input type="checkbox"/>	\$1,006	<input type="checkbox"/>	\$1,006	<input type="checkbox"/>	\$1,006	<input type="checkbox"/>	\$1,006	<input type="checkbox"/>	\$1,006

FS Mounting Hardware

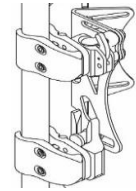

JAY J3 Posterior Lateral (PL) BACK - 3" Contour Depth

	Shell Height	Shell Width										
		12"		14"		16"		18"		20"		
Mid Thoracic (MT)	15.0" (T)	J3PLMTTxxFS	<input type="checkbox"/>	\$965	<input type="checkbox"/>	\$965	<input type="checkbox"/>	\$965	<input type="checkbox"/>	\$965	<input type="checkbox"/>	\$965
		J3PLMTTxxTH	<input type="checkbox"/>	\$965	<input type="checkbox"/>	\$965	<input type="checkbox"/>	\$965	<input type="checkbox"/>	\$965	<input type="checkbox"/>	\$965
Upper Thoracic (UT)	16.5" (S)	J3PLUTSxxFS	<input type="checkbox"/>	\$1,047	<input type="checkbox"/>	\$1,047	<input type="checkbox"/>	\$1,047	<input type="checkbox"/>	\$1,047	<input type="checkbox"/>	\$1,047
		J3PLUTSxxTH	<input type="checkbox"/>	\$1,047	<input type="checkbox"/>	\$1,047	<input type="checkbox"/>	\$1,047	<input type="checkbox"/>	\$1,047	<input type="checkbox"/>	\$1,047
	18.0" (M)	J3PLUTMxxFS	<input type="checkbox"/>	\$1,047	<input type="checkbox"/>	\$1,047	<input type="checkbox"/>	\$1,047	<input type="checkbox"/>	\$1,047	<input type="checkbox"/>	\$1,047
		J3PLUTMxxTH	<input type="checkbox"/>	\$1,047	<input type="checkbox"/>	\$1,047	<input type="checkbox"/>	\$1,047	<input type="checkbox"/>	\$1,047	<input type="checkbox"/>	\$1,047
	19.5" (T)	J3PLUTTxxFS	<input type="checkbox"/>	\$1,047	<input type="checkbox"/>	\$1,047	<input type="checkbox"/>	\$1,047	<input type="checkbox"/>	\$1,047	<input type="checkbox"/>	\$1,047
		J3PLUTTxxTH	<input type="checkbox"/>	\$1,047	<input type="checkbox"/>	\$1,047	<input type="checkbox"/>	\$1,047	<input type="checkbox"/>	\$1,047	<input type="checkbox"/>	\$1,047
Shoulder Height (SH)	21.0" (S)	J3PLSHSxxFS	<input type="checkbox"/>	\$1,076	<input type="checkbox"/>	\$1,076	<input type="checkbox"/>	\$1,076	<input type="checkbox"/>	\$1,076	<input type="checkbox"/>	\$1,076
		J3PLSHSxxTH	<input type="checkbox"/>	\$1,076	<input type="checkbox"/>	\$1,076	<input type="checkbox"/>	\$1,076	<input type="checkbox"/>	\$1,076	<input type="checkbox"/>	\$1,076
	22.5" (M)	J3PLSHMxxFS	<input type="checkbox"/>	\$1,076	<input type="checkbox"/>	\$1,076	<input type="checkbox"/>	\$1,076	<input type="checkbox"/>	\$1,076	<input type="checkbox"/>	\$1,076
		J3PLSHMxxTH	<input type="checkbox"/>	\$1,076	<input type="checkbox"/>	\$1,076	<input type="checkbox"/>	\$1,076	<input type="checkbox"/>	\$1,076	<input type="checkbox"/>	\$1,076
	24.0" (T)	J3PLSHTxxFS	<input type="checkbox"/>	\$1,076	<input type="checkbox"/>	\$1,076	<input type="checkbox"/>	\$1,076	<input type="checkbox"/>	\$1,076	<input type="checkbox"/>	\$1,076
		J3PLSHTxxTH	<input type="checkbox"/>	\$1,076	<input type="checkbox"/>	\$1,076	<input type="checkbox"/>	\$1,076	<input type="checkbox"/>	\$1,076	<input type="checkbox"/>	\$1,076

TH Mounting Hardware

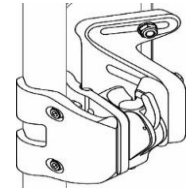

JAY J3 Posterior Deep (PD) BACK - 6" Contour Depth

Mid Thoracic (MT)	15.0" (T)	J3PDMTTxxFS	<input type="checkbox"/>	\$1,057	<input type="checkbox"/>	\$1,057	<input type="checkbox"/>	\$1,057	<input type="checkbox"/>	\$1,057	<input type="checkbox"/>	\$1,057
		J3PDMTTxxTH	<input type="checkbox"/>	\$1,057	<input type="checkbox"/>	\$1,057	<input type="checkbox"/>	\$1,057	<input type="checkbox"/>	\$1,057	<input type="checkbox"/>	\$1,057
Upper Thoracic (UT)	18.0" (M)	J3PDUTMxxFS	<input type="checkbox"/>	\$1,144	<input type="checkbox"/>	\$1,144	<input type="checkbox"/>	\$1,144	<input type="checkbox"/>	\$1,144	<input type="checkbox"/>	\$1,144
		J3PDUTMxxTH	<input type="checkbox"/>	\$1,144	<input type="checkbox"/>	\$1,144	<input type="checkbox"/>	\$1,144	<input type="checkbox"/>	\$1,144	<input type="checkbox"/>	\$1,144
Shoulder Height (SH)	21.0" (S)	J3PDSHSxxFS	<input type="checkbox"/>	\$1,219	<input type="checkbox"/>	\$1,219	<input type="checkbox"/>	\$1,219	<input type="checkbox"/>	\$1,219	<input type="checkbox"/>	\$1,219
		J3PDSHSxxTH	<input type="checkbox"/>	\$1,219	<input type="checkbox"/>	\$1,219	<input type="checkbox"/>	\$1,219	<input type="checkbox"/>	\$1,219	<input type="checkbox"/>	\$1,219

JAY J3 Back Whitmyer Headrest

AXYS Mount and Pad

<input type="checkbox"/>	J3HEDX8	AXYS Headrest with 8" Plush Pad	\$397.00
<input type="checkbox"/>	J3HEDX10	AXYS Headrest with 10" Plush Pad	\$397.00
<input type="checkbox"/>	J3HEDX14	AXYS Headrest with 14" Plush Pad	\$397.00
<input type="checkbox"/>	J3HEDXAAPN	AXYS with Adj-a-Plush Narrow Pad	\$543.00
<input type="checkbox"/>	J3HEDXAAPS	AXYS with Adj-a-Plush Std Pad	\$543.00

LINX Mount and Pad

<input type="checkbox"/>	J3HEDL8	LINX Headrest with 8" Plush Pad	\$236.00
<input type="checkbox"/>	J3HEDL10	LINX Headrest with 10" Plush Pad	\$236.00
<input type="checkbox"/>	J3HEDL14	LINX Headrest with 14" Plush Pad	\$248.00
<input type="checkbox"/>	J3HEDLAAPN	LINX with Adj-a-Plush Narrow Pad	\$363.00
<input type="checkbox"/>	J3HEDLAAPS	LINX with Adj-a-Plush Std Pad	\$363.00

JAY J3 Back Laterals Swing Away Laterals With Pad - Pair

<input type="checkbox"/>	JLATS44PR	SwingAway Lat with 4"x4" Pad (PR)	\$658.00	<input type="checkbox"/>	JLATS46PR	SwingAway Lat with 6"x4" Pad (PR)	\$658.00
<input type="checkbox"/>	JLATS45PR	SwingAway Lat with 4"x5" Pad (PR)	\$658.00	<input type="checkbox"/>	JLATS65PR	SwingAway Lat with 6"x5" Pad (PR)	\$658.00
<input type="checkbox"/>	JLATS46PR	SwingAway Lat with 4"x6" Pad (PR)	\$658.00	<input type="checkbox"/>	JLATS66PR	SwingAway Lat with 6"x6" Pad (PR)	\$658.00



JAY® Signature Series Cushions

Note: Not all sizes and configurations shown below, for full offering visit www.sunrisemedical.ca.
When ordering mark the part number desired and it will be added to the order as a separate line item .

JAY CUSHIONS

JAY Fusion Cushion			
<input type="checkbox"/>	JFUSION1416	JAY Fusion 14" x 16"	\$1,030.00
<input type="checkbox"/>	JFUSION1616	JAY Fusion 16" x 16"	\$1,030.00
<input type="checkbox"/>	JFUSION1618	JAY Fusion 16" x 18"	\$1,030.00
<input type="checkbox"/>	JFUSION1620	JAY Fusion 16" x 20"	\$1,030.00
<input type="checkbox"/>	JFUSION1717	JAY Fusion 17" x 17"	\$1,030.00
<input type="checkbox"/>	JFUSION1816	JAY Fusion 18" x 16"	\$1,030.00
<input type="checkbox"/>	JFUSION1818	JAY Fusion 18" x 18"	\$1,030.00
<input type="checkbox"/>	JFUSION1820	JAY Fusion 18" x 20"	\$1,030.00
<input type="checkbox"/>	JFUSION2018	JAY Fusion 20" x 18"	\$1,030.00
<input type="checkbox"/>	JFUSION2020	JAY Fusion 20" x 20"	\$1,030.00
<input type="checkbox"/>	JFUSION2220	JAY Fusion 22" x 20"	\$1,155.00

JAY Fusion Cushion w/ Single Valve Air Insert			
<input type="checkbox"/>	JFUSION1416AS	JAY Fusion 14" x 16"	\$1,030.00
<input type="checkbox"/>	JFUSION1616AS	JAY Fusion 16" x 16"	\$1,030.00
<input type="checkbox"/>	JFUSION1618AS	JAY Fusion 16" x 18"	\$1,030.00
<input type="checkbox"/>	JFUSION1620AS	JAY Fusion 16" x 20"	\$1,030.00
<input type="checkbox"/>	JFUSION1717AS	JAY Fusion 17" x 17"	\$1,030.00
<input type="checkbox"/>	JFUSION1816AS	JAY Fusion 18" x 16"	\$1,030.00
<input type="checkbox"/>	JFUSION1818AS	JAY Fusion 18" x 18"	\$1,030.00
<input type="checkbox"/>	JFUSION1820AS	JAY Fusion 18" x 20"	\$1,030.00
<input type="checkbox"/>	JFUSION2018AS	JAY Fusion 20" x 18"	\$1,030.00
<input type="checkbox"/>	JFUSION2020AS	JAY Fusion 20" x 20"	\$1,030.00
<input type="checkbox"/>	JFUSION2220AS	JAY Fusion 22" x 20"	\$1,155.00

JAY Fusion Cushion w/ Dual Valve Air Insert			
<input type="checkbox"/>	JFUSION1416AD	JAY Fusion 14" x 16"	\$1,047.00
<input type="checkbox"/>	JFUSION1616AD	JAY Fusion 16" x 16"	\$1,047.00
<input type="checkbox"/>	JFUSION1618AD	JAY Fusion 16" x 18"	\$1,047.00
<input type="checkbox"/>	JFUSION1620AD	JAY Fusion 16" x 20"	\$1,047.00
<input type="checkbox"/>	JFUSION1717AD	JAY Fusion 17" x 17"	\$1,047.00
<input type="checkbox"/>	JFUSION1816AD	JAY Fusion 18" x 16"	\$1,047.00
<input type="checkbox"/>	JFUSION1818AD	JAY Fusion 18" x 18"	\$1,047.00
<input type="checkbox"/>	JFUSION1820AD	JAY Fusion 18" x 20"	\$1,047.00
<input type="checkbox"/>	JFUSION2018AD	JAY Fusion 20" x 18"	\$1,047.00
<input type="checkbox"/>	JFUSION2020AD	JAY Fusion 20" x 20"	\$1,047.00
<input type="checkbox"/>	JFUSION2220AD	JAY Fusion 22" x 20"	\$1,173.00

JAY Union Cushion			
<input type="checkbox"/>	JU1416	JAY UNION 14" x 16"	\$753.00
<input type="checkbox"/>	JU1616	JAY UNION 16" x 16"	\$753.00
<input type="checkbox"/>	JU1618	JAY UNION 16" x 18"	\$753.00
<input type="checkbox"/>	JU1620	JAY UNION 16" x 20"	\$753.00
<input type="checkbox"/>	JU1717	JAY UNION 17" x 17"	\$753.00
<input type="checkbox"/>	JU1816	JAY UNION 18" x 16"	\$753.00
<input type="checkbox"/>	JU1818	JAY UNION 18" x 18"	\$753.00
<input type="checkbox"/>	JU1820	JAY UNION 18" x 20"	\$794.00
<input type="checkbox"/>	JU2018	JAY UNION 20" x 18"	\$794.00
<input type="checkbox"/>	JU2020	JAY UNION 20" x 20"	\$794.00
<input type="checkbox"/>	JU2220	JAY UNION 22" x 20"	\$794.00

JAY Union Reduced Profile Cushion			
<input type="checkbox"/>	JU1416RP	JAY Union RP 14" x 16"	\$753.00
<input type="checkbox"/>	JU1616RP	JAY Union RP 16" x 16"	\$753.00
<input type="checkbox"/>	JU1618RP	JAY Union RP 16" x 18"	\$753.00
<input type="checkbox"/>	JU1620RP	JAY Union RP 16" x 20"	\$753.00
<input type="checkbox"/>	JU1717RP	JAY Union RP 17" x 17"	\$753.00

JAY J2 Cushion			
<input type="checkbox"/>	2108-MJ	JAY J2 14" x 16"	\$820.00
<input type="checkbox"/>	2105-MJ	JAY J2 15.5" x 16"	\$820.00
<input type="checkbox"/>	2106-MJ	JAY J2 15.5" x 18"	\$820.00
<input type="checkbox"/>	2107-MJ	JAY J2 15.5" x 20"	\$944.00
<input type="checkbox"/>	2117-MJ	JAY J2 17" x 17"	\$820.00
<input type="checkbox"/>	2100-MJ	JAY J2 18" x 16"	\$820.00
<input type="checkbox"/>	2101	JAY J2 18" x 18"	\$820.00
<input type="checkbox"/>	2103-MJ	JAY J2 18" x 20"	\$944.00
<input type="checkbox"/>	2118-MJ	JAY J2 20" x 18"	\$927.00
<input type="checkbox"/>	2102-MJ	JAY J2 20" x 20"	\$1,096.00

JAY J2 Deep Contour Cushion			
<input type="checkbox"/>	2446	JAY J2 Deep Contour 14" x 16"	\$857.00
<input type="checkbox"/>	2466	JAY J2 Deep Contour 16" x 16"	\$857.00
<input type="checkbox"/>	2468	JAY J2 Deep Contour 16" x 18"	\$857.00
<input type="checkbox"/>	2460	JAY J2 Deep Contour 16" x 20"	\$931.00
<input type="checkbox"/>	2477	JAY J2 Deep Contour 17" x 17"	\$857.00
<input type="checkbox"/>	2486	JAY J2 Deep Contour 18" x 16"	\$857.00
<input type="checkbox"/>	2488	JAY J2 Deep Contour 18" x 18"	\$857.00
<input type="checkbox"/>	2480	JAY J2 Deep Contour 18" x 20"	\$931.00
<input type="checkbox"/>	2408	JAY J2 Deep Contour 20" x 18"	\$931.00
<input type="checkbox"/>	2400-MJ	JAY J2 Deep Contour 20" x 20"	\$1,077.00
<input type="checkbox"/>	2428	JAY J2 Deep Contour 22" x 18"	\$1,077.00

JAY X2 Cushion			
<input type="checkbox"/>	JX21416	JAY X2 14" x 16"	\$930.00
<input type="checkbox"/>	JX21616	JAY X2 16" x 16"	\$930.00
<input type="checkbox"/>	JX21618	JAY X2 16" x 18"	\$930.00
<input type="checkbox"/>	JX21620	JAY X2 16" x 20"	\$930.00
<input type="checkbox"/>	JX21717	JAY X2 17" x 17"	\$930.00
<input type="checkbox"/>	JX21816	JAY X2 18" x 16"	\$930.00
<input type="checkbox"/>	JX21818	JAY X2 18" x 18"	\$930.00
<input type="checkbox"/>	JX21820	JAY X2 18" x 20"	\$930.00
<input type="checkbox"/>	JX22020	JAY X2 20" x 20"	\$930.00

JAY Ion Cushion			
<input type="checkbox"/>	JION1416	JAY ION 14" x 16"	\$647.00
<input type="checkbox"/>	JION1616	JAY ION 16" x 16"	\$647.00
<input type="checkbox"/>	JION1618	JAY ION 16" x 18"	\$647.00
<input type="checkbox"/>	JION1620	JAY ION 16" x 20"	\$647.00
<input type="checkbox"/>	JION1717	JAY ION 17" x 17"	\$647.00
<input type="checkbox"/>	JION1816	JAY ION 18" x 16"	\$647.00
<input type="checkbox"/>	JION1818	JAY ION 18" x 18"	\$647.00
<input type="checkbox"/>	JION1820	JAY ION 18" x 20"	\$647.00
<input type="checkbox"/>	JION2018	JAY ION 20" x 18"	\$688.00
<input type="checkbox"/>	JION2020	JAY ION 20" x 20"	\$688.00
<input type="checkbox"/>	JION2220	JAY ION 22" x 20"	\$688.00

<input type="checkbox"/>	JU1816RP	JAY Union RP 18" x 16"	\$753.00
<input type="checkbox"/>	JU1818RP	JAY Union RP 18" x 18"	\$753.00
<input type="checkbox"/>	JU1820RP	JAY Union RP 18" x 20"	\$753.00
<input type="checkbox"/>	JU2018RP	JAY Union RP 20" x 18"	\$753.00
<input type="checkbox"/>	JU2020RP	JAY Union RP 20" x 20"	\$753.00

